

## Featured Articles II

# New Globally Standardized Machine-room-less Elevator —Satisfying Customer Needs in the Asian and Middle Eastern Markets—

Tetsuji Ono  
Hironori Fukata  
Yoshihiro Tomaru  
Takanori Katada  
Kitsawat Kongsamran  
Luk Soo Pung

*OVERVIEW: In September 2016, Hitachi released new machine-room-less elevators for markets in Asia and the Middle East where economic development is driving rising demand for medium-high- and mid-range elevators. The new models utilize numerous functions and design features from Hitachi's standard machine-room-less elevator for the Japanese market, while also taking account of various national regulatory and market requirements, and are available with an extensive range of specifications. In addition to improving product competitiveness, including smaller hoistway dimensions than previous models, the standardization of core specifications has provided the flexibility to meet customers' requirements with a short lead time.*

## INTRODUCTION

IN the past, Hitachi's elevator business in Asian and Middle Eastern markets has operated in the high-end segment with a focus on order-made elevators. Prompted by growth in the medium-high- and mid-range segments driven by economic development in these countries, however, Hitachi released its new globally standardized machine-room-less elevator with standardized specifications in September 2016<sup>(1)</sup>.

Targeting the Asian and Middle Eastern markets, the new models are positioned as globally standardized models that offer a range of specifications to meet diverse customer requirements, and also feature enhancements to their visual designs.

Manufacturing technologies that support the launch of these new models on the market and enhance their competitiveness include use of modular design, functional safety features already used in the Japanese market, and standardization of key components for Chinese market models. They are also designed to place less of a load on the environment, with the power consumption of core functions having been reduced through the adoption of light-emitting diode (LED) lighting as a standard feature, system efficiencies, and other measures.

This article describes the work leading up to the market launch of the new globally standardized machine-room-less elevators and the technologies used.

## REVISION OF SALES PRACTICES —SHIFT TO CATALOG SALES—

Hitachi has in the past sought to expand sales in Asian and Middle Eastern markets by offering fully order-made elevators that can adapt flexibly to customer requirements, with most sales coming from high-class hotels and high-rise office or residential buildings. Hitachi has satisfied a wide variety of customer requirements in this market segment by supplying the new Hitachi order-made machine-room-less elevator.

Now, Hitachi has recognized the need to develop products that suit market conditions in the volume segment in emerging economies if it is to increase deliveries further, and has set about developing a new globally standardized machine-room-less elevator.

Along with the shift to a new sales practice whereby elevators are chosen from catalog specifications rather than being custom-built, a sales promotion infrastructure has been established for Hitachi's new globally standardized machine-room-less elevator together with shorter lead times and better on-site

working practices through an innovation project that drew on capabilities from all along the value chain, from sales to production, installation, and maintenance.

### SATISFACTION OF MARKET REQUIREMENTS —WIDER RANGE OF DESIGNS AND OPTIONS—

The new globally standardized models utilize numerous functions and design features from Hitachi’s standard machine-room-less elevator for the Japanese market, while also taking account of various national

regulatory and market requirements. With an expanded lineup of models for Asian and Middle Eastern markets, Hitachi is providing products that satisfy a wider range of customer needs (see Fig. 1).

#### Expanded Range of Design Variations

Hitachi offers a range of functions for providing users with real-time elevator information using liquid crystal display (LCD) indicators in the elevator cars and halls. An extensive range of design variations are available, with new ceiling designs added for the Asian and Middle Eastern markets (see Fig. 2).

#### Provision of Reassurance and Comfort

The available functions include a door signal with a blinking LED embedded in the door safety edge to provide a visual warning to users that the doors are about to close as they enter the elevator from the hall, and a function to prevent users from getting stuck in the door by use of a multi-beam door sensor to detect them as they enter and exit.

To make the car interior more pleasant, an ion generator is mounted on top of the car to keep the air fresh through the deodorizing effect of ions (see Fig. 3).



Fig. 1—Product Concept.

The product catalog was designed with the earth tones as a base, which are preferred in the Asian markets, so as to present the simplicity and appeal of the products based on market needs.

### MANUFACTURING INITIATIVES —UPGRADING OF MAIN COMPONENTS—

The practice for the new globally standardized machine-room-less elevators for Asian and Middle Eastern markets is to install equipment in the hoistway in accordance with global market requirements.

Based on production at the facility of Siam-Hitachi Elevator Co., Ltd. in the Kingdom of Thailand, Hitachi’s core factory in the Asia region, the new models incorporate a structural design that takes account of parts procurement, and component



Fig. 2—Car Interior Design.

As in Japanese designs, a range of downlighting and indirect lighting options are available for car ceilings, with a choice of different design patterns to provide an extensive range of variations.

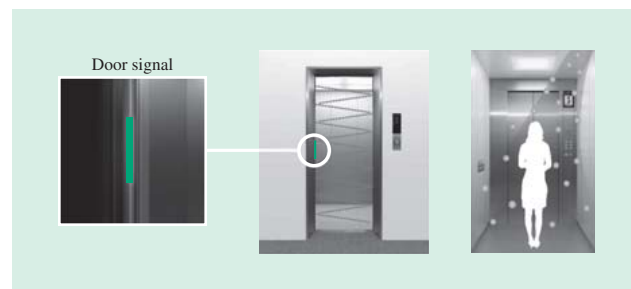

Fig. 3—Multi-beam Door Sensor with Door Signal (Left) and Ion Generator (Right).

The signal color and blink timing of the door sensor were determined from the results of a monitor survey.

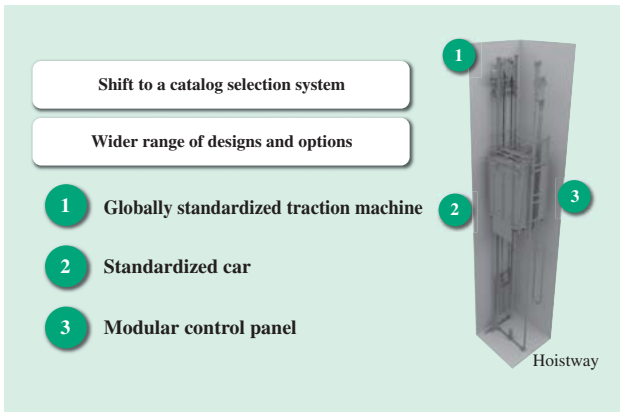

Fig. 4—Main Components of Hitachi’s New Globally Standardized Machine-room-less Elevator.  
Hitachi is increasingly adopting global production practices using overseas factories to improve productivity and to promote global standardization.

standardization is used to make production easier. This section describes some typical examples (see Fig. 4).

**Global Sharing of Traction Machine Parts**

The new globally standardized machine-room-less elevators feature a thin-profile traction machine that is mounted at the top of the hoistway (see Fig. 5).

Traction machines for the Chinese market, which are available in a series of models with different brake positions and work with the power supply specifications of different markets, are also used in Asia. These traction machines are designed with main components that have the same design and parts as the traction machines for the Japanese market, which are mounted at the bottom of the hoistway. This was done to reduce machinery costs by standardizing equipment globally.

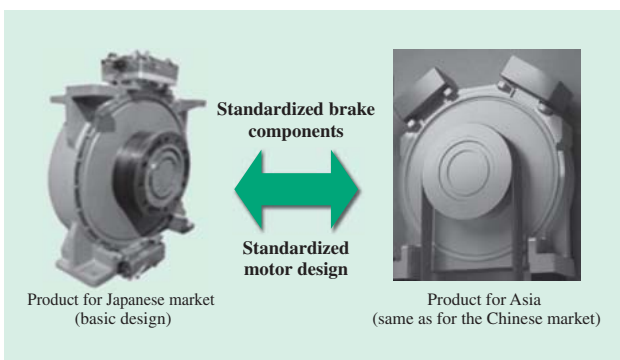

Fig. 5—Globally Standardized Traction Machine Design.  
By using a standardized core design for the motor while allowing the brake position to be modified, the traction machine can be mounted either on the top or the bottom.

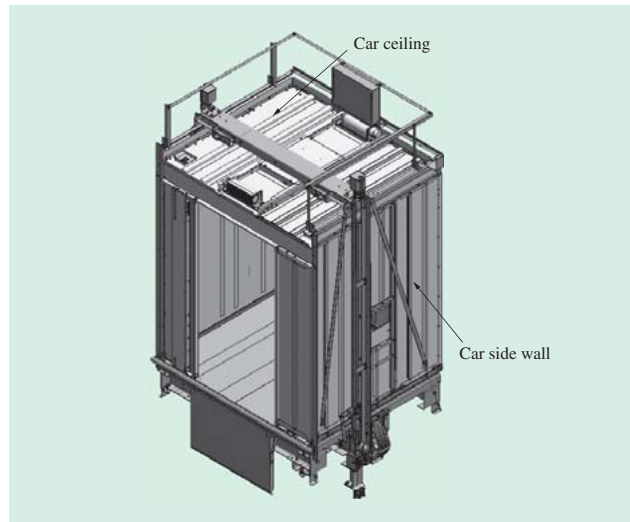

Fig. 6—Structural Design of Elevator Car.  
The car side walls and ceiling are built from box-shaped panels of uniform size. Use of welding is eliminated by using metal plating for structural components that is fastened by bolt or rivet.

**Standardization of Car Structural Design**

Hitachi has implemented design standardization of the structural components of cars, not only in consideration of product costs, but also in terms of productivity and making work easier. Metal plating is used for components that provide structural strength, and bolts and rivets are used to eliminate the need for steel sections or welding. To ensure the design is suitable for automated production lines, the car side walls and ceiling are made from box-shaped panels and assembled by fitting these together.

Installing the car side walls has been made easier by designing them to be assembled from inside the car (see Fig. 6).

**Modular Design of Control Panels**

Hitachi optimized the design of the control panels for the new models to reduce costs through volume production.

The control panels were separated into a main circuit unit for motor drive control and a control unit that controls the elevator cars. To cut costs, parts and equipment were standardized by using a control unit that is not dependent on the elevator load and speed (see Fig. 7).

Hitachi standardized the installation and maintenance work by using the same components, which helped improve productivity and maintain quality at the installation site. Adopting this practice made changing the capacity and other aspects of application design easier, resulting in a design that is useful for expanding the product series.

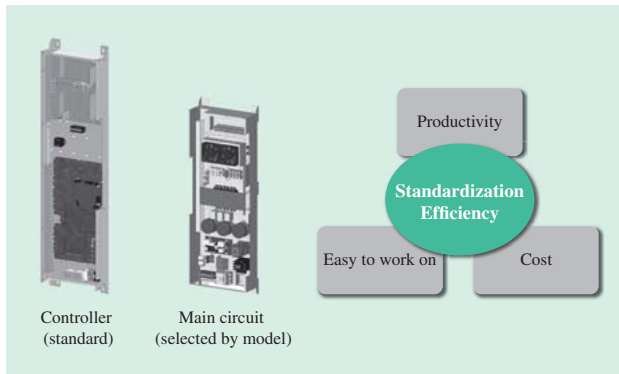

Fig. 7—Modular Design of the Control Panels.  
A standard module is used for all controllers and a range of different main circuits are provided for different elevator capacities.

## APPLICATION OF NEW TECHNOLOGIES —COMMERCIALIZATION OF TECHNOLOGIES FOR FUNCTIONAL SAFETY AND ENERGY EFFICIENCY—

Standards stipulate the installation of safety devices to keep elevator users safe and the provision of circuits for bringing the elevator to a safe halt when devices are activated. Elevator over-speed or overshooting can be detected more quickly and accurately using electronic safety equipment than it can with the mechanical systems used in the past, and this can save space in the hoistway along which the elevator travels. Hitachi is using this technology to improve performance, including in ultra-high-speed elevators that are among the world's fastest<sup>(2)</sup>.

Along with offering a wider range of design variations to achieve harmony with the increasingly diverse interiors of buildings, Hitachi has also achieved greater reductions in power consumption to help reduce the load on the environment. This section describes the energy efficiency improvements made in the new globally standardized models.

### Use of Functional Safety Technologies and Compliance with Non-Japanese Standards

Improvements in accuracy and functionality can be achieved by using electronic circuits and programs that run on microcomputers to build elevator safety functions that were previously implemented using mechanical switches and relay circuits (see Fig. 8). These technologies are typically referred to as functional safety technologies and are used for safety functions in robots and vehicles. They need to provide the same level of reliability as safety functions

implemented using mechanical switches and relays, with the assessment of that reliability being the key point.

In non-Japanese standards, this assessment of electronic circuits and programs that are not visible to the eye is defined under the title, “Programmable Electronic Systems in Safety Related Applications for Lifts” and includes procedures not only for assessing the reliability of electronic circuits, but also the reliability of programs. Hitachi evaluates system safety and reliability, including the assessment of backup functions for various types of faults, in accordance with the European EN 81 standards and has acquired assessment certification from a third-party accreditation body.

### Use of Functional Safety Systems

Along with high accuracy and functionality, the digitization of elevator safety functions also helps shorten the time it takes for maintenance and improve work safety by enabling component parts to be reduced in size and consolidated.

The storage and analysis of elevator operation data collected by this system will help to make elevators even better through its use for improving performance in future product development and for developing new services.

### Use of Energy-efficient Technologies

LEDs are used for all ceiling lights to improve energy efficiency and to extend the operating life of the lighting.

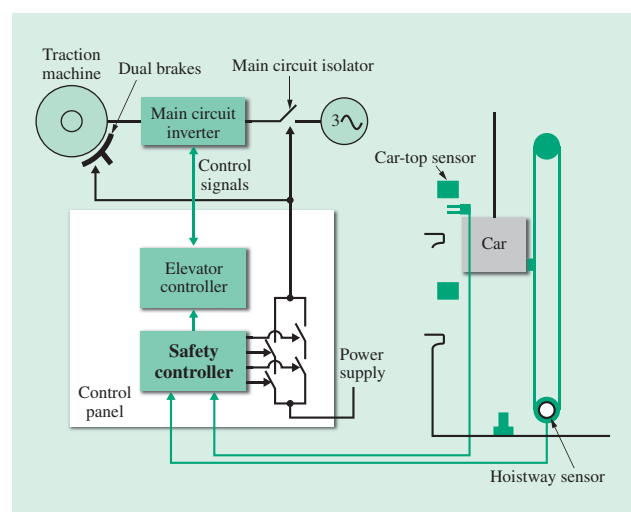

Fig. 8—Block Diagram of the Functional Safety System.  
Along with the existing control equipment, safety has been improved by providing an additional safety controller that is independent of the sensors and elevator control.



Reducing the use of control power while the elevator is in standby helps cut power consumption and carbon dioxide (CO<sub>2</sub>) emissions.

The elevators also make use of regenerative power from the motor depending on the operating conditions, such as when ascending with a small number of passengers or when descending with a large number of passengers.

The energy efficiency of the elevators has been assessed based on the ISO 25745 international standard and has obtained class A, the top class in terms of energy efficiency (see Fig. 9). This activity also will be continued for new models that are developed in the future.

### CONCLUSIONS

This article has described the product development work and product features for Hitachi’s standard elevators for the Asian and Middle Eastern markets that went on sale in September 2016.

In the future, Hitachi will continue working toward building sales in Thailand, Republic of the Philippines, India, and other parts of Asia and the Middle East where it operates elevator and escalator businesses, with the aim of achieving annual deliveries of around 5,000 units, while also expanding its sales region.

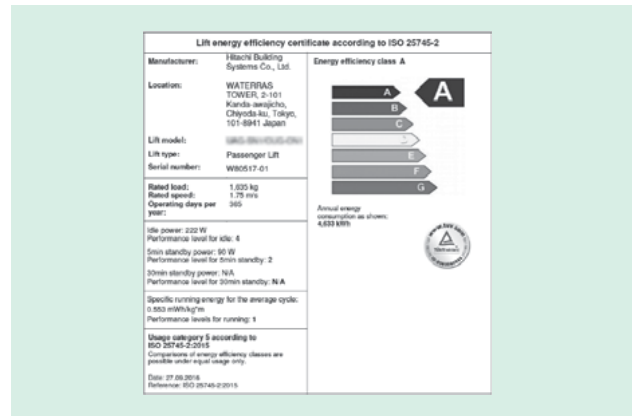

Fig. 9—Energy Efficiency Certificate. The energy efficiency of Hitachi’s new globally standardized machine-room-less elevator was assessed together with a third party and it obtained class A, the top class for energy efficiency (the actual class depends on additional specifications and operating conditions).

### REFERENCES

- (1) Hitachi News Release, “Hitachi Launches New Machine Room-less Elevator for Asia and the Middle East,” (Sep. 2016), <http://www.hitachi.com/New/cnews/month/2016/09/160926a.html>
- (2) S. Inoue et al., “Development of Electronic Safety System for Elevator,” Proceedings of 2015 IEEE Industry Applications Society Conference (Sep. 2015) in Japanese.

### ABOUT THE AUTHORS



**Tetsuji Ono**  
Elevator Development Department, Global Development Division, Global Elevator & Escalator Division, Building Systems Business Unit, Hitachi, Ltd. He is currently engaged in the development of elevator mechanical equipment and systems.



**Hironori Fukata**  
Elevator Development Department, Global Development Division, Global Elevator & Escalator Division, Building Systems Business Unit, Hitachi, Ltd. He is currently engaged in the development of elevator mechanical equipment and systems.



**Yoshihiro Tomaru**  
Product Planning Department, Product Strategy Division, Global Business Strategy Planning Division, Building Systems Business Unit, Hitachi, Ltd. He is currently engaged in the planning of elevator products.



**Takanori Katada**  
SCM Strategy Department, Product Strategy Division, Global Business Strategy Planning Division, Building Systems Business Unit, Hitachi, Ltd. He is currently engaged in the strategic planning of elevator supply chains.



**Kitsawat Kongsamran**  
Standardization Department, VEC & Design Division, Siam-Hitachi Elevator Co., Ltd. He is currently engaged in the management and practice of standardization for elevators manufactured in Thailand (including Hitachi’s new globally standardized machine-room-less elevator and others).



**Luk Soo Pung**  
Research & Development Department, Design Division, Hitachi Elevator Asia Pte. Ltd. He is currently engaged in the management of the new development of elevator mechanical equipment, and the practice of applied design and technology study thereof.