

Technology Innovation

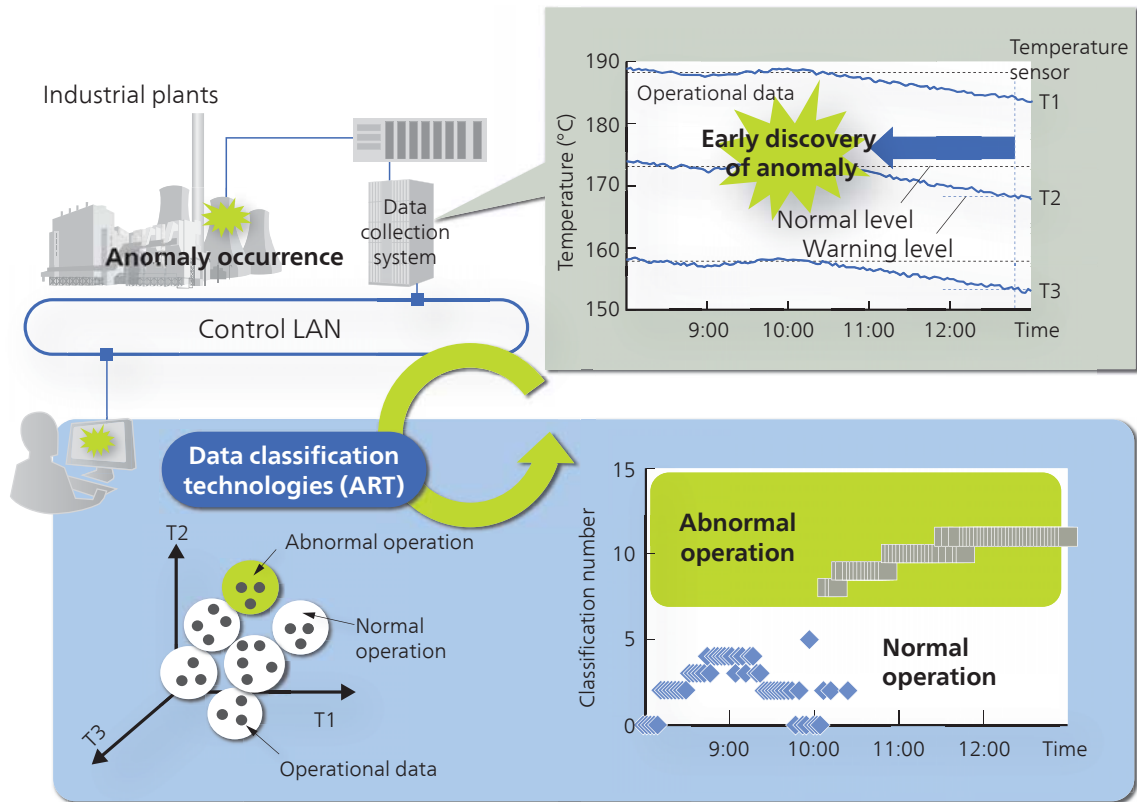

LAN: local area network

1 Anomaly diagnosis system using ART data classification technologies

1 High-efficiency Operational Support Technologies for Industrial Plants

Power generating facilities and industrial plants need to maximize operational efficiency by optimizing operating conditions based on fuel and raw material lot changes, aging deterioration of equipment, and so on. Hitachi has developed high-efficiency operational support technologies for industrial plants that detect equipment anomalies and inappropriate operating states early on and provide guidance towards optimum conditions, and verified the effectiveness of the technologies in a joint effort with the Universiti Teknologi PETRONAS.

With conventional anomaly diagnosis technologies that are based on initial conditions, as fluctuations within normal operating ranges are also determined to be “anomalous,” the application of these technologies in places where the conditions considered appropriate can change on a daily basis has been difficult.

On the other hand, Hitachi’s newly developed

technology employs a sequential learning-type data classification technology known as adaptive resonance theory (ART). Since ART can teach a system the “normal” conditions that correspond to a wide range of operating states, anomalies can be detected accurately.

A pilot plant for distillation towers, a key piece of equipment used in crude oil refining plants, was used to verify the system. Even when the composition of the raw materials changed, it was demonstrated that anomalies such as malfunctioning flow adjustment valves and sensor drift could be detected.

Moving forward, Hitachi will demonstrate loss cost reductions at customer plants through this technology.

2 Power Plant Maintenance Technologies to Improve Reliability and Economy

Hitachi has developed two maintenance technologies that contribute to improved reliability and economy at nuclear power and thermal power plants.

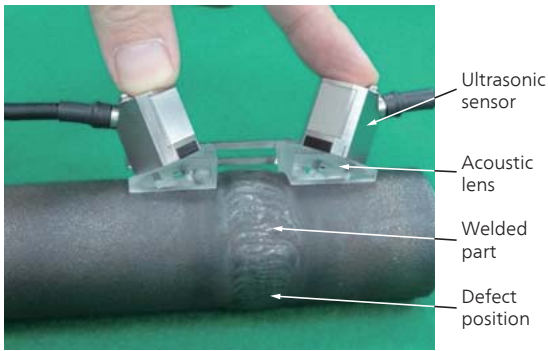

2 Ultrasonic inspection technology using acoustic lenses for welded part of pipe

The first is an ultrasonic inspection technology that can detect defects to a high degree of sensitivity to maintain the health of plant piping and equipment. To detect cracks that form longitudinally along piping welded parts, placing a pair of ultrasonic sensors symmetrically on either side of a welded part is an effective method. An ultrasonic beam is sent and received in the longitudinal direction of the pipe, and the propagation path of the beam within the piping material is predicted using a 3D ultrasonic simulation. The beam spread that occurs due to the piping curvature is controlled using acoustic lenses, and by delivering a high-intensity beam, small cracks with a depth of 1 mm can be detected.

The other advance is a corrosion resistance technology that uses a platinum nano colloid solution produced by gamma-ray irradiation. Platinum particles with an average diameter of 2 nm are injected into nuclear reactor coolant water and adhere to the surface of the material. By reducing the corrosion potential of the material surface, corrosion degradation of the material is controlled to extend the life of piping and equipment.

These maintenance technologies can help to prevent unplanned shutdowns associated with deterioration of the equipment and structures that make up power plants and improve the load factor.

3 Video Analysis Technology to Detect Divergent Operations by Site Workers

With demands to ensure quality at manufacturing sites even higher, on-site improvements through four Ms management (the management of man, machine, material and method) has become increasingly important. As a measure to enhance the management of site workers, Hitachi has developed technology to detect operations divergent from normal ones.

With conventional technologies, when information on joint positions such as a worker's hands, elbows and shoulders are used as inputs, information that does not

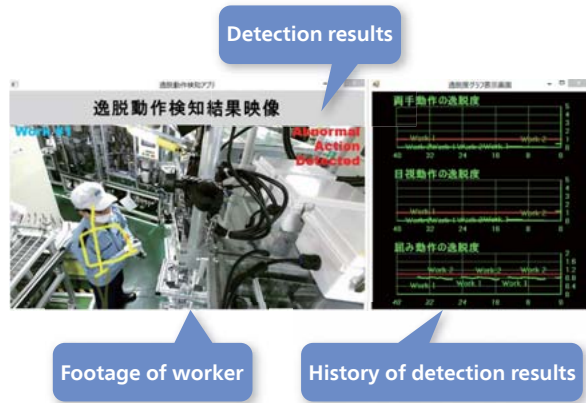

3 Running screen of divergent operation detection

impact the operation results is also included and distinguishing that information from actual divergent operations has been difficult. Given this, Hitachi normalized individual differences attributable to body size, and based on on-site observation, extracted only the information related to the work through joint selection. Next, by comparing models of normal operation prepared in advance against actual operations in statistical terms, the detection of divergent operation was achieved. Hitachi will work on a joint basis with Daicel Corporation to confirm the effectiveness of this technology, and Daicel will deploy a manufacturing control system that utilizes the technology to its Harima Plant and six overseas plants. Hitachi also aims to offer the technology to the manufacturing industry in Japan and abroad as one of the core solutions in its Internet of Things (IoT) platform, Lumada.

4 Technologies to Measure People's Behavior and Estimate Their Attributes Using 3D Video Analysis

In recent years, services that enhance users' experiential value by measuring the flow and behavior of people at offices and commercial facilities have attracted attention as a way of addressing increasingly diverse individual needs.

In the latest such advancement, Hitachi has developed a technology that uses stereo camera-based 3D video analysis to measure people's behavior and estimate their attributes, such as elderly people requiring assistance or users accompanied by children. The process is performed in real-time, and to a high degree of accuracy. Regular surveillance cameras can suffer from degraded measurement accuracy depending on the filming environment, such as areas congested with people, and to obtain some measure of performance, time is taken to adjust parameters on-site. However, through 3D data analysis and the simplification of parameter adjustments,

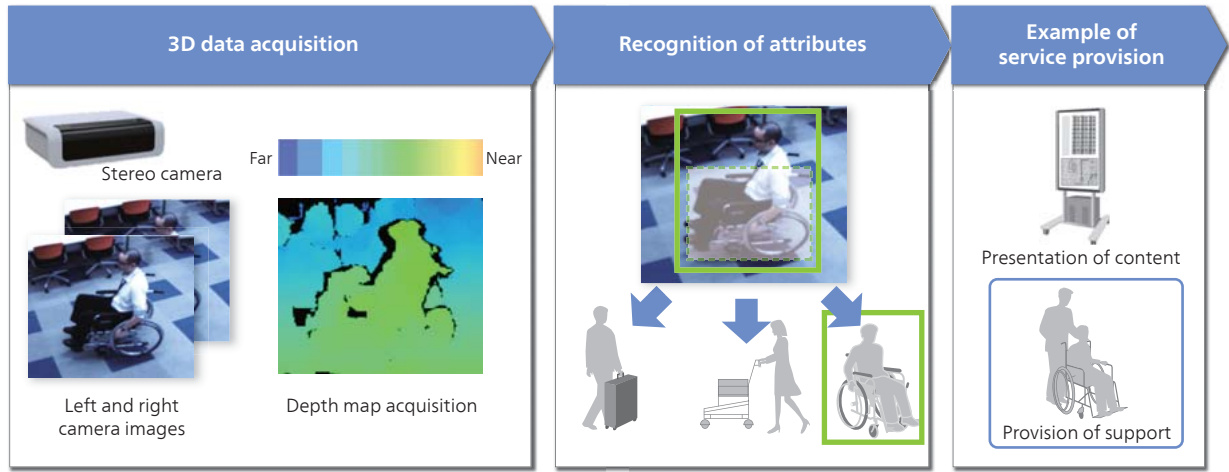

4 Example of stereo camera-based attribution estimation and service provision

this new technology improves the tracking rate of subjects by 30% over previous attempts, and reduces the time from camera installation to operational start by 75%. In addition, objects such as wheelchairs are recognized based on shape data around a subject. Estimating specific attributes in this way enables the provision of services that cater to individuals.

Looking ahead, Hitachi will promote the practical utilization of this technology and contribute to the development of more comfortable urban spaces and improve the sophistication of social infrastructure.

5 Flexible Production System Involving Cooperation between Human Workers and Robots

With the globalization of production and diversification of consumer needs, businesses need to handle high-mix

variable-volume production and short-life-cycle products. Given this need, Hitachi has developed a flexible production system that involves cooperation between human workers and robots and enables adjustments to production capacity in a short time to respond to production volume fluctuations. This is achieved with the addition of a feature that optimizes combinations of human and robot cells for a system that automatically generates the information needed to prepare for production, such as production line configuration.

The system determines an assembly sequence based on inter-component constraints shown in the 3D computer-aided design (CAD). By appropriately dividing work between human workers able to perform complex tasks and robots that can perform repetitious work with accuracy, the system controls equipment

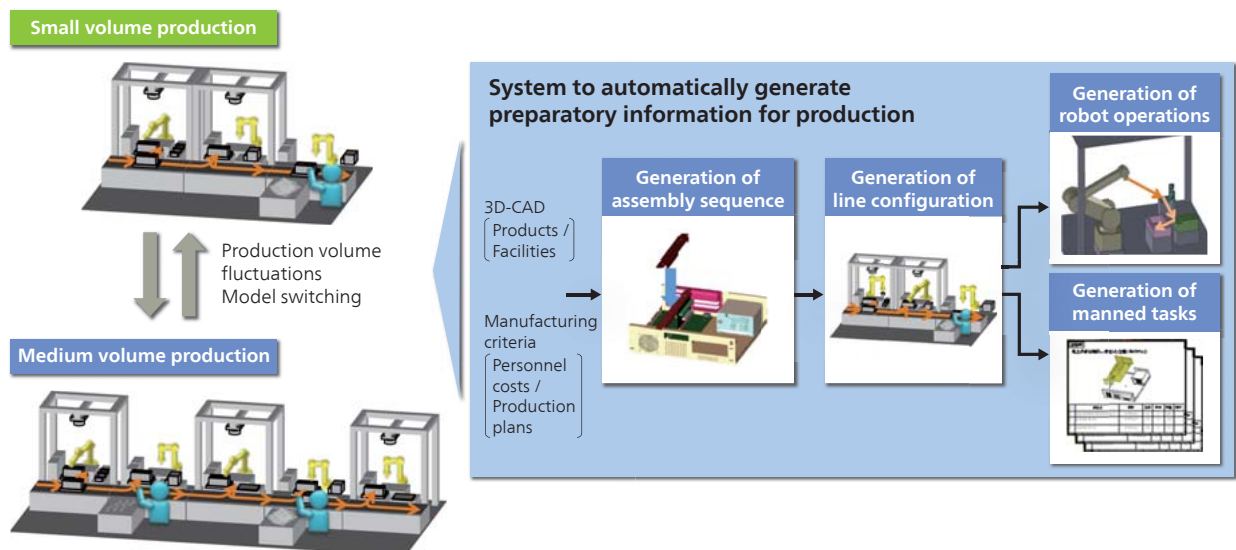

5 Overview of a flexible production system involving cooperation between human workers and robots

investment and personnel costs while automatically generating high-productivity production line configurations. The system has drastically shortened the time taken to prepare for production from the previous 40 days to five days.

Moving forward, Hitachi will promote expanded application of the system at its in-house manufacturing sites and pursue its commercial application as a manufacturing solution for outside customers, particularly in the automotive and precision equipment industries.

6 CAE Automation Technology to Automatically Generate High-quality Analysis Models

With the aim of improving the precision of simulations such as vehicle collision analysis and reducing workload, Hitachi has developed a technology that utilizes proven high-quality analysis models to automatically generate overall analysis models for newly designed shapes.

Since work to generate analysis models has traditionally required specialized expertise, it is highly dependent on individual skills and quality can vary depending on the worker. The number of person-hours required has also been an issue. To address this, Hitachi has developed a similar sub-parts search technology that searches for similar sub-parts from past analysis models, and an analysis model unification technology that arranges and joints meshes of searched similar sub-parts to conform to a newly designed shape.

Reusing proven analysis models, enables mesh generation to the same standards of quality as previously, and helps to reduce the hours spent on model generation. As a result of verifying the technology with automotive

resin components, Hitachi has succeeded in reducing the person-hours spent on analysis model creation by more than 30%.

The computer-aided engineering (CAE) modeling platform which employs this analysis model generating system has already been provided to several domestic automakers and Hitachi also has plans to offer the system as a cloud service in the future.

(Commercialization: December 2015)

7 Vibration Control Technologies to Improve Riding Comfort in High-speed Elevators

Hitachi has developed an active damping system to reduce horizontal vibrations of elevator cars in high-speed elevators traveling at 1,200 m/min.

Traditional damping systems for the 600 m/min. class of elevator involved the installation of acceleration sensors and active guide units at two points on the underside of the elevator car. However, as the high-speed elevators generate complex vibrations that involve a horizontal mode and rotational modes due to slight rail curves and level differences, acceleration sensors and active guide units were installed at four points around the car, top, bottom, left and right, in an effort to improve riding comfort in this new development.

The issue with this technology is that the control parameters increase in step with the addition of active guide units, significantly increasing the on-site calibration work required. For this latest advancement, Hitachi developed an algorithm that automatically derives control calibration amounts by identifying the vibrational modes produced based on acceleration data collected from in-service elevators. That application of

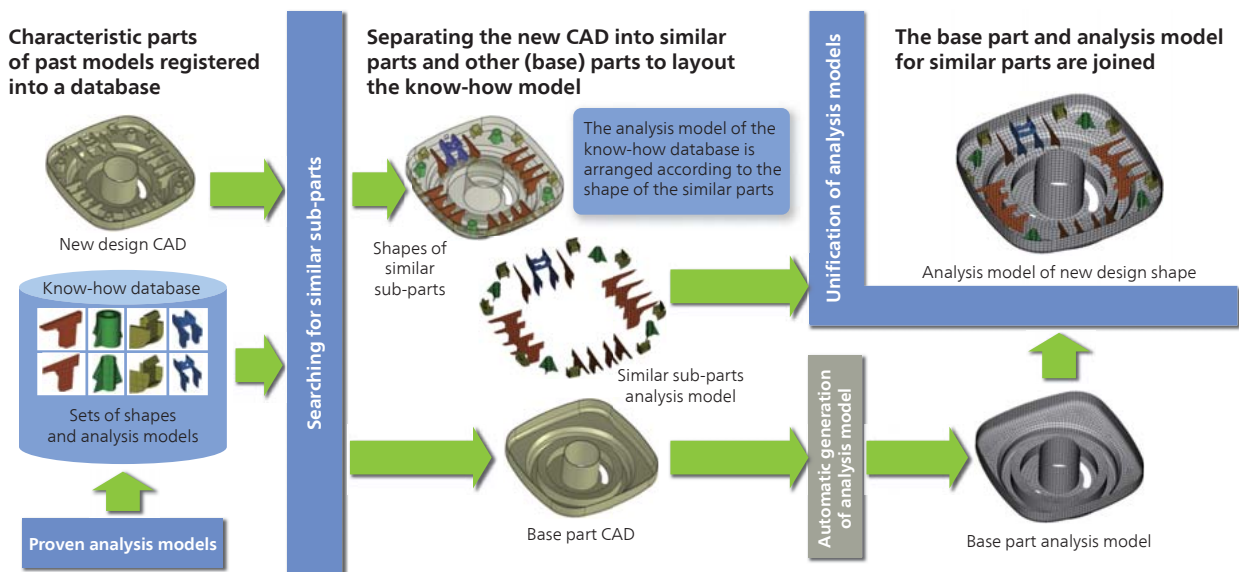

6 Automated mesh generation process

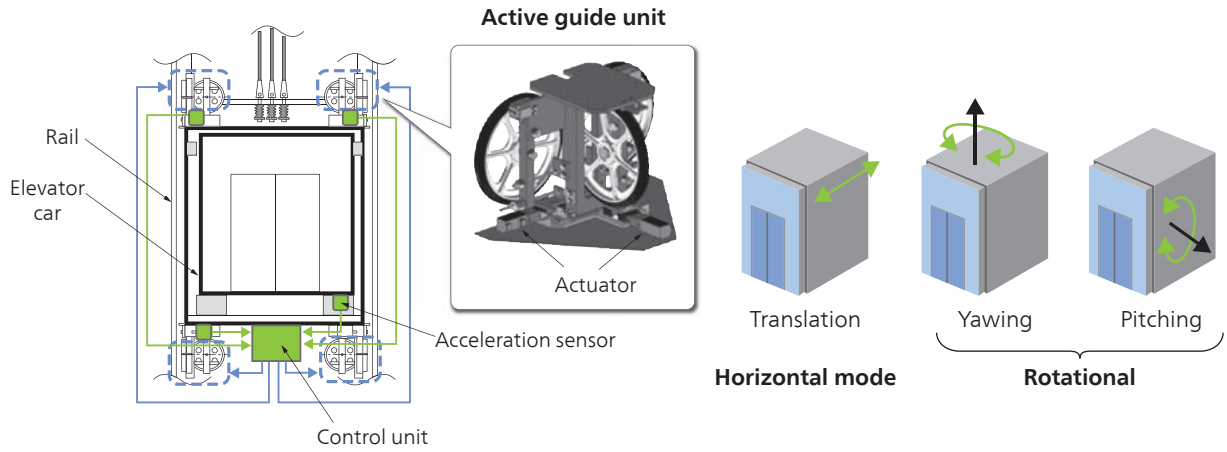

7 Active damping system and vibration mode

this calibration method in the field satisfied demands for damping performance over a short period.

Moving forward, Hitachi plans to progressively apply this method in the expanding global market.

8 High-reliability SiC MOSFET Technology for Railway Inverter Diode-less All-SiC Module

Power devices using silicon carbide (SiC) are attracting growing attention as key devices enabling smaller and more energy-efficient power converters such as inverters. SiC possesses excellent material properties

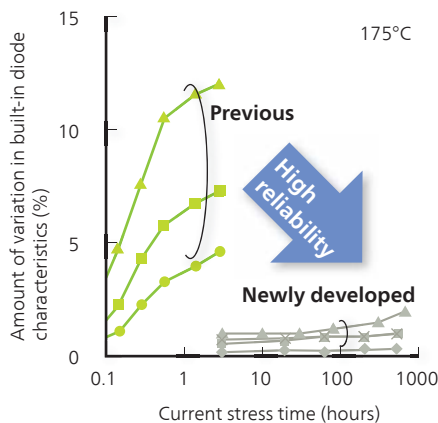
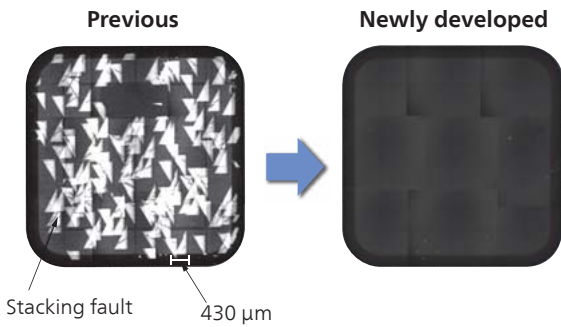

8 Development of low-defect built-in PN diode forming process to offer improved reliability

that allow high-voltage, low-loss power devices to be created.

Hitachi recently developed the following technologies for 3.3 kV railway inverter power modules by adopting the perspective of improving device reliability and lowering costs.

- (1) Technology to extend the life of gate insulator and form gate electrodes subject to minimal stress.
- (2) Impurity diffusion layer forming technology to balance electric field relaxation with lower resistance during on-operation.
- (3) High-quality manufacturing process and screening technology to eliminate external diodes as a module protection element and replace them with built-in PN diodes.

By combining high-reliability SiC metal-oxide-semiconductor field-effect transistor (MOSFET) devices that apply these technologies with low-inductance mounting package technologies, Hitachi has succeeded in developing diode-less all SiC modules.

9 Low Loss and Low Noise IGBT Side Gate HiGT

The CO₂ reductions required by 2015 United Nations Climate Change Conference, Conference of the Parties (COP21) require the widespread adoption of energy-efficient power converters such as inverters. As a key device in converters, power semiconductors need to continuously improve their low-loss and low-noise characteristics to facilitate device miniaturization, greater efficiency and higher reliability. It has been around 35 years since the development of the insulated gate bipolar transistor (IGBT), the mainstay of power semiconductors. Over this time, the gate structure has been improved with planar gate structures and trench gate structures, enhancing performance.

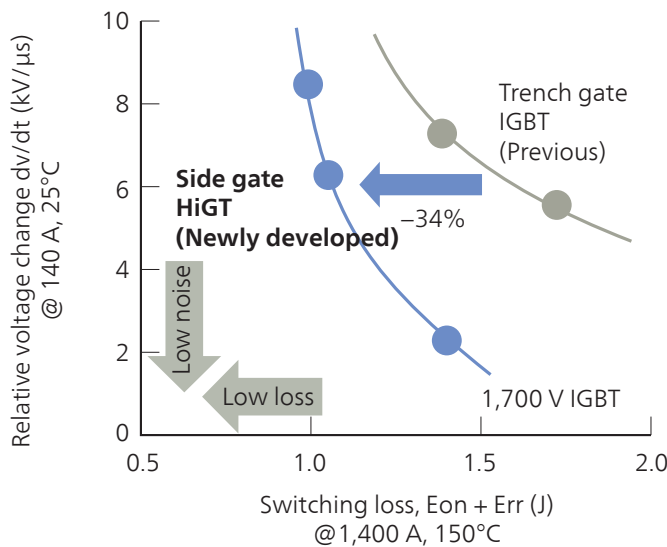
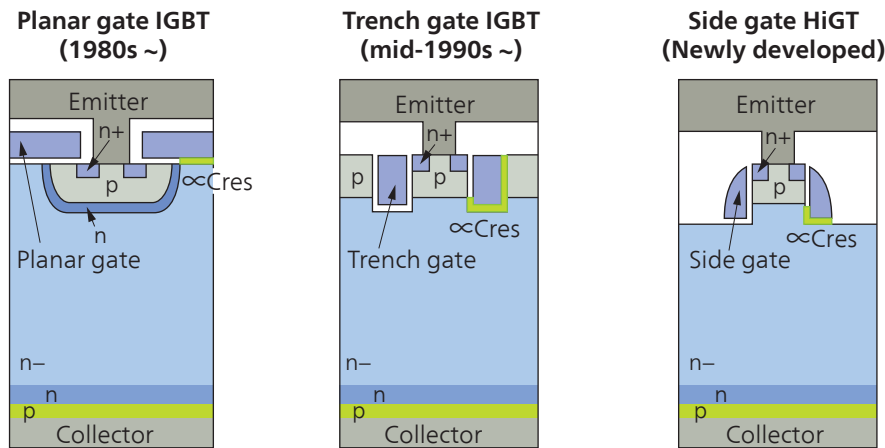

9 Historical changes in IGBT device structure (top) and low-loss, low-noise effects of side gate HiGT (bottom)

In the latest development, Hitachi has developed the side gate high-conductivity IGBT (HiGT), the first new gate structure in around two decades. By adopting a gate structure with side walls, the side gate HiGT reduces the facing surface area between gate and collector, reducing gate feedback capacitance (C_{res}), which causes noise, by 1/4 compared with the conventional trench gate structure. In addition, by improving the tradeoff between loss during switching and relative voltage change (dv/dt), Hitachi has managed to decrease switching loss by 34% under the same dv/dt conditions and strike a balance between lower loss and reduced noise.

10 Targeted Cyber-attack Spread Attempt Detection Technologies

In recent years, targeted attacks on the organizational networks of government entities and companies with the aim of leaking information or damaging systems have been on the increase. The techniques employed by

attackers have become increasingly sophisticated, such as the malicious use of legitimate tools like standard operating system (OS) commands, and it is still hard to detect attacks through conventional measures such as antivirus packages monitoring and analyzing individual terminals.

It is believed that to discover the signs of a sophisticated attack, integrated analysis that correlates the actions taken by multiple terminals is required. In response, Hitachi has focused on the phenomenon where terminals repeatedly performing suspicious actions not seen under normal conditions appear one after another, as part of the process where an attacker gains access to nearby terminals to get what they are after. With the new technology, machine learning is used to identify suspicious activity, detect suspicious terminals suspected of having been compromised and capture the scenario in which multiple suspicious terminals appear in cascading fashion based on communication logs.

This makes it possible to detect targeted cyber-attacks that involve the malicious use of legitimate tools,

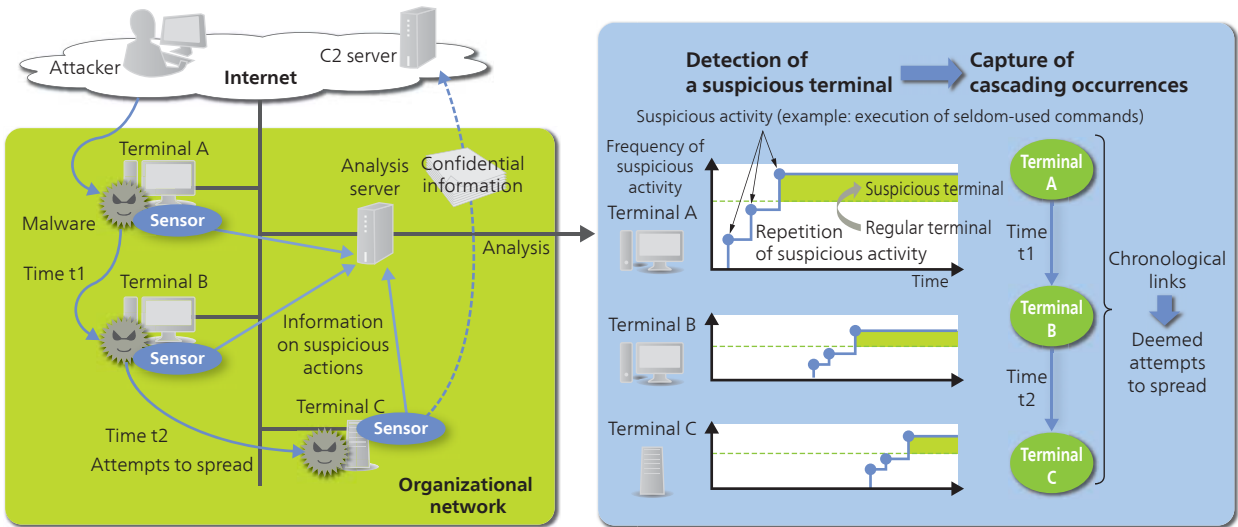

C2: command and control, NW: network

10 Overview of attack detection through technologies that detect attempts to spread

something that has traditionally proven difficult.

In the future Hitachi plans to apply technology across a broad range of fields including social infrastructure and IoT.

11 High-reliability Blockchain Technologies Enabling Services for Cooperation across Business Categories

As social issues become more complex and make it harder to solve issues within a single business category, blockchain (BC), which enables open and secure transactions across different business categories, has attracted attention. In response, Hitachi has developed services for cooperation across business categories and a high-reliability BC infrastructure to support it as one

way to solve social issues. One such example is power transaction, which matches various electric power supply and demand needs and stabilizes the electric power system. Hitachi aims to apply these technologies to social infrastructure.

With BC, processing performance and privacy protection are issues as the details of transactions are approved, shared and agreed to by all users. Towards solving this issue, Hitachi will offer high-reliability features as an add-in to the global standard BC infrastructure to establish a high-speed, high-reliability BC infrastructure. Specifically, by splitting the processing nodes responsible for forming agreement into multiple groups and performing parallel processing, processing can be sped-up, while the privacy of users

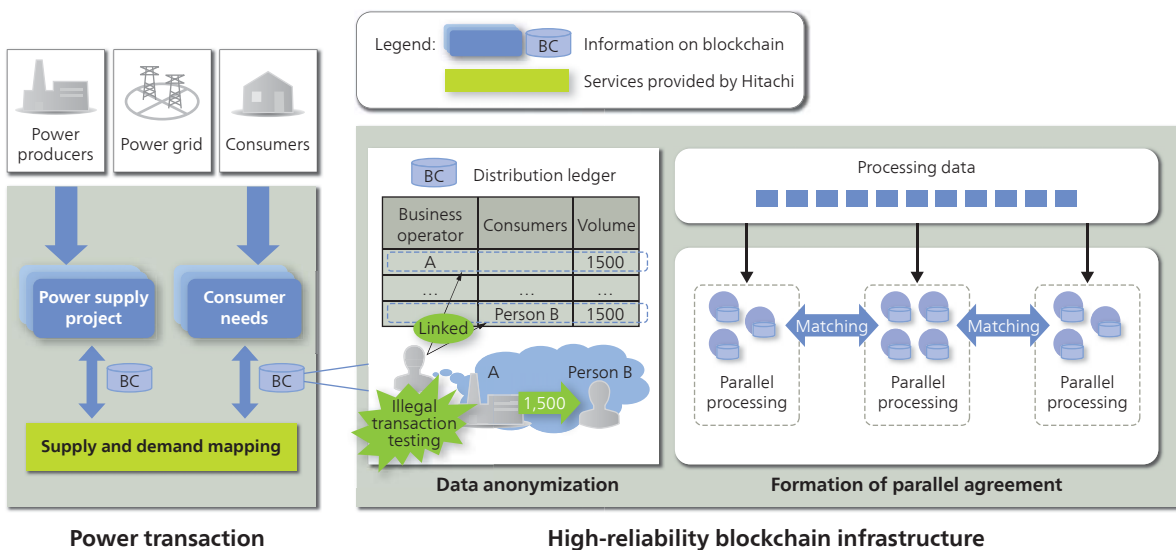

11 Overview of the high-reliability blockchain infrastructure

can be protected through data anonymization utilizing an encryption methods known as zero-knowledge proof.

In the future, by increasing the throughput of data in its anonymized form to a hundred times greater than previous speeds and satisfying the performance requirements needed for regular online transactions, Hitachi will contribute to business dealings that span business categories through the social implementation of BC.

12 Technical Document Analysis Technology for Oil Field Development Solution

Operators and service providers in the upstream business of oil and gas development are striving to reduce the cost of mining operations. However, under conventional approaches, simulations were conducted based on reservoir models developed with the use of limited types of sensor data, and the cost reductions were insufficient as a result.

To address this, Hitachi developed solutions for oil and gas, a data-driven oilfield development solution that utilizes a wide variety of data. As geological reports are saved in an image-based document format, technical document analysis technologies capable of extracting data from images are a key part of the solution.

The technology analyzes the layout of a large volume of geological reports released by the government through techniques based on rules and deep learning, after which optical character recognition (OCR) and language processing technologies are used to identify

feature quantities related to rocks, such as color or the presence of oil stains. Using the identified characteristics, Hitachi has already observed a 30% improvement in prediction accuracy for production volume from existing oil wells, and the technology is expected to bring vast improvements to the efficiency of well exploration.

Through the technical document analysis technology, it is now possible to add data that could not be utilized until now for oil field production volume predictions. The technology stands as a core technology for solutions in oil and gas and has developed into a data-driven cost reduction solution for customers pursuing upstream operations in oil and gas development. In the future, Hitachi will also expand into the maintenance business in various fields such as thermal power plants and construction machinery by making the technical document analysis technology available on its Lumada IoT platform.

13 IoT Data Modeling Technology for Mixed Environments Comprising Many Sensors

In recent years, the efforts to solve business issues using big data generated by IoT have spread in the manufacturing industry, electric power industry and elsewhere. By installing a wide range of sensors for variables such as temperature, humidity and pressure and acquiring product quality data or operational data on power generating equipment in fine detail, the number of companies managing to reduce defective work costs and improve productivities is on the rise.

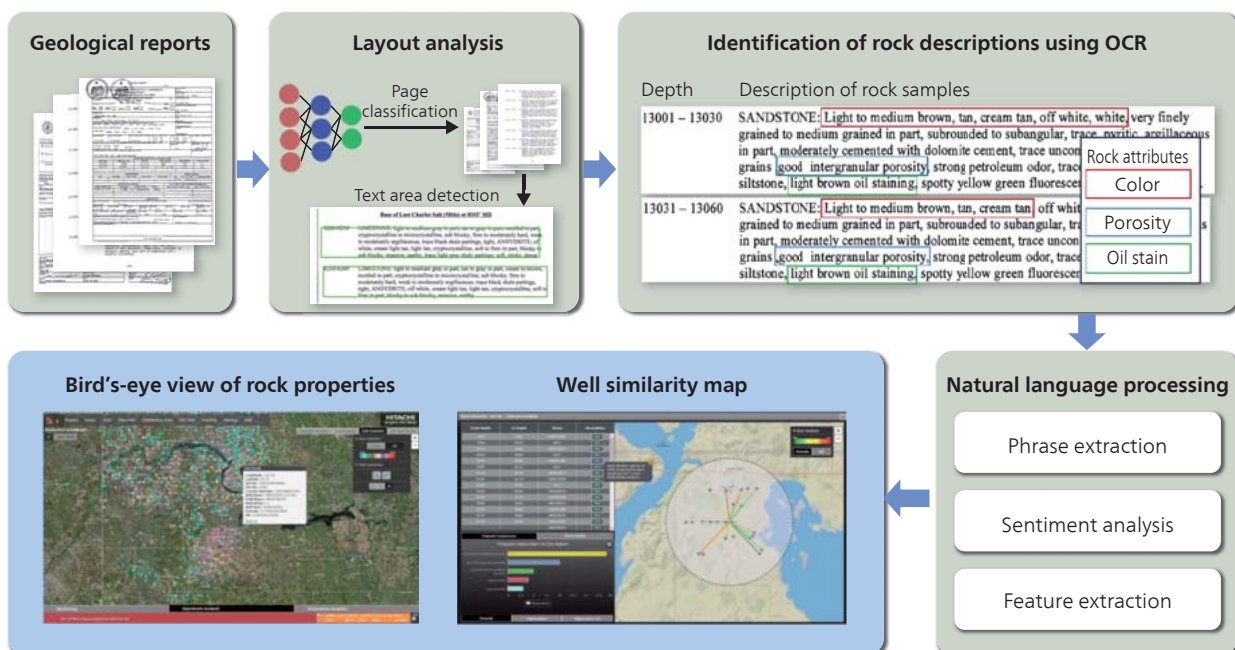

12 Overview of technical document analysis technologies

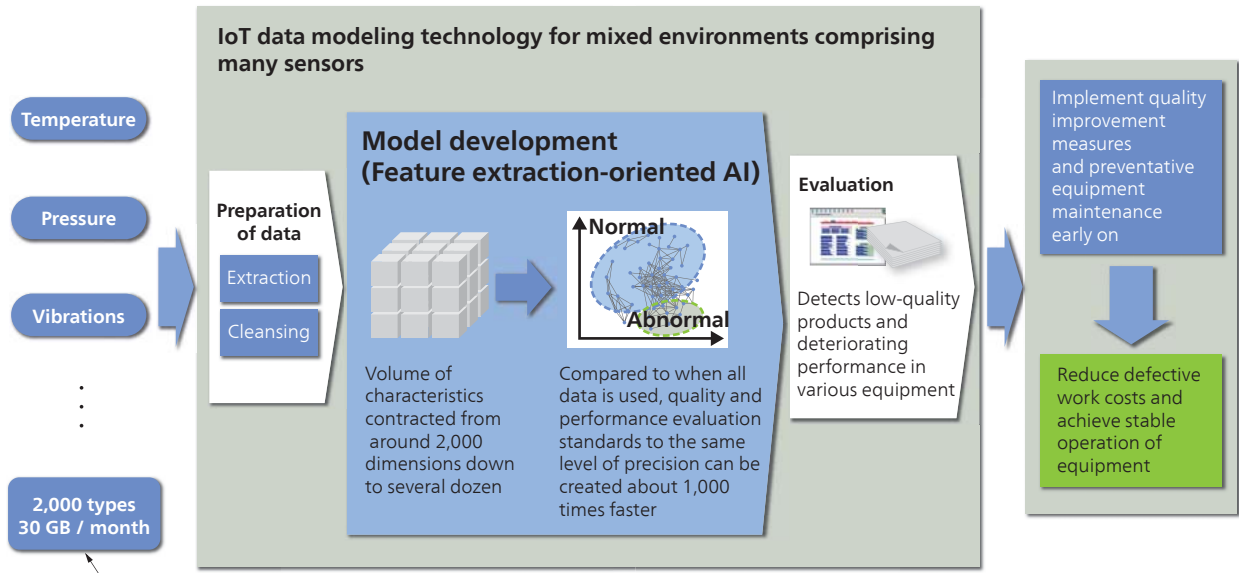

Actual example of the sensor data used for production quality analysis at a Hitachi plant

13 IoT data modeling technology for mixed environments comprising many sensors (for manufacturing and electric power businesses)

However, analyzing the big data corresponding to a wide variety of sensors is by no means an easy task. This is because due to growth in the types of sensors and volume of data, it can take an enormous amount of time to identify a data type matching the purpose of analysis, interpolate as to the defective parts, delete duplicate data, and so on.

Hitachi has developed an IoT data modeling technology that works through feature extraction-oriented artificial intelligence (AI) to extract several dozen types of data highly correlated to the purpose of analysis from among several thousand types of big data. The technology cannot only shorten data extraction time but also the subsequent data analysis time by several hundred or several thousand times. Moreover, by eliminating the data that is not needed for analysis, the accuracy of analysis is also expected to improve. This technology could enable early quality improvements and reduced defective work costs in the manufacturing sector, and facilitate the stable operation of equipment through preventative maintenance of transmission lines and electrical equipment in the electric power industry.

for storing data and server equipment that carries out data analysis. Of these components, data read performance has increased a hundredfold over previous offerings thanks to the widespread adoption of flash storage. Accordingly, by installing a hardware accelerator capable of the parallel execution of analytical processing in the server equipment and optimizing the management size of data stored in the flash storage for the accelerator, Hitachi managed to speed up the processing performance of the data analysis system overall by up to one hundred times. Hitachi plans to conduct field verification of the technology in actual business settings.

14 Technology for the High-speed Analysis of Large Volumes of Data Using Accelerators

With a wide variety of companies launching efforts to utilize the large volume of data that has been rapidly generated through IoT, analysis systems that extract value from the vast quantity of data require a swiftness that satisfies business speeds.

The data analysis system comprises storage equipment

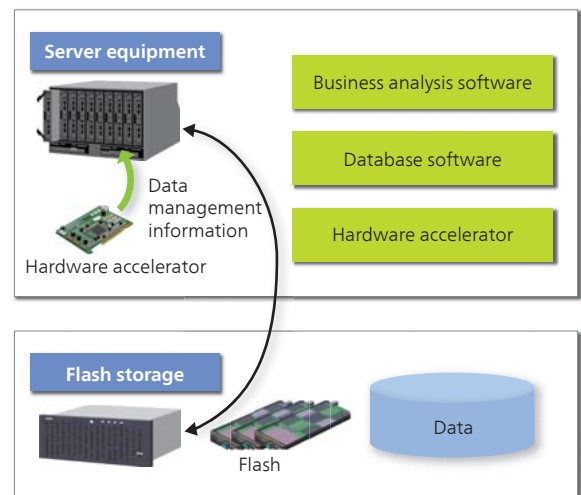

14 Analysis system configuration

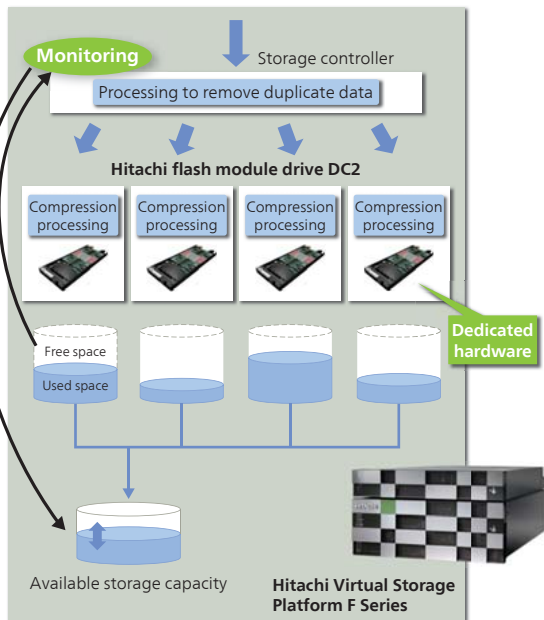

15 Hitachi Virtual Storage Platform F Series data reduction features and capacity management

15 Data Reduction Technologies for the All-flash Array Virtual Storage Platform F Series

For the need to analyze a large amount of data in short time, all-flash arrays using high performance flash memory are becoming common. Although the per-bit cost of flash memory has continued to fall each year, it remains expensive compared with that of conventional hard disk drives (HDDs).

Hitachi has developed a high-speed data compression feature that strikes a balance between access performance and the reduction of data volume. It has been realized

that the dedicated hardware inside multiple Hitachi flash module drives (FMDs) DC2 equipped in the Hitachi Virtual Storage Platform F Series performs the distributed execution of data compression. To further reduce the volume of data, Hitachi will also offer a feature that uses a storage controller to detect when the same data is contained on multiple drives and combine the data to remove duplicates.

These features allow data to be stored in one-fifth or less of the space it previously took up, and helps reduce total costs in terms of space, power consumption and so on.

Hitachi will continue to pursue the development of technologies that support utilization of the growing amount of data produced.

16 High-speed Data Transmission and Receiving Technologies for Communications inside Data Centers with Deteriorating Signal Quality

To achieve an IoT system that analyzes large volumes of data to enhance user value, it is essential to increase the speed of the information equipment at data centers such as servers and storage. However, as equipment increases in speed, copper wire cables experience increased signal loss, making long-distance communications difficult. For example, a communication distance of 10 m may be required to connect two pieces of information equipment with one another, but when a 25 Gbps signal is transmitted over a 10 m copper wire cable, signal amplitude shrinks to 1/300th the size during transmission.

To address this, Hitachi developed an integrated circuit (IC) for wired transmission and receiving. The

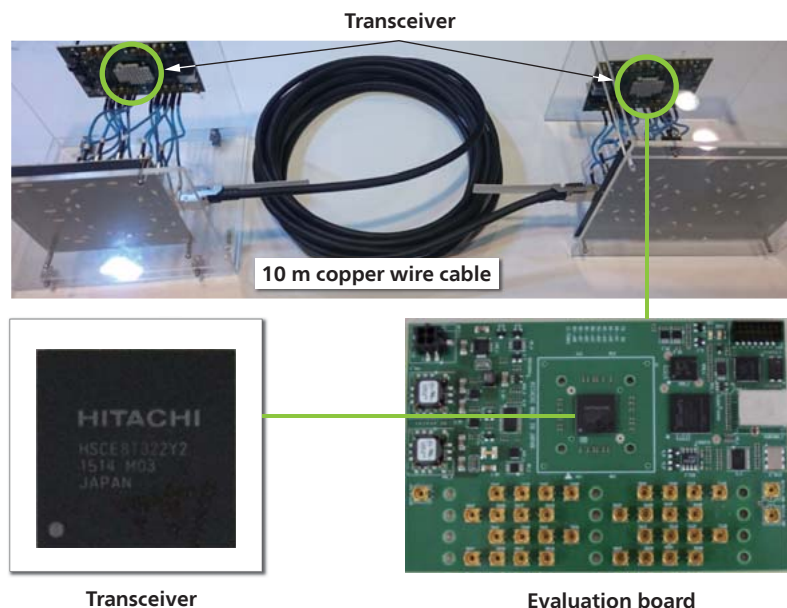

16 Transmitting a 25 Gbps signal over a 10 m cable

IC applies high-sensitivity data reproduction technology to boost weak signals and dynamic signal compensation technology to suppress the signal degradation that occurs due to manufacturing variations and environmental changes, resulting in a 10 dB improvement in minimum receiving sensitivity compared with previous products. The results of 25 Gbps signal transmission tests using this transmission and receiving IC over a 10 m copper wire cable confirmed that no errors were produced in the data. Through this technology, users can achieve 25 Gbps communications between information equipment over low-cost copper wire cabling without having to use expensive fiber optic cable, making it possible to reduce data center costs.

17 Identifying Finger-tapping Exercise Patterns Unique to Alzheimer's-type Dementia Symptoms

With the advance of the aging society, the number of patients with Alzheimer's-type dementia is increasing with each year. As the advance of the disease can be slowed if it is discovered early, simple screening tests are needed. While simple tests such as blood tests and smell tests are known, the pain when drawing blood and the time taken to carry out tests have emerged as issues.

In joint research with the National Center for Geriatrics and Gerontology, Hitachi has proposed measuring finger-tapping exercises involving the repeated opening and closing of the thumb and index finger as a test that is non-invasive and can be carried out in a short time. Using a finger tapping device with magnetic sensors developed by Hitachi, the center measured finger-tapping exercises carried out with both hands by subjects with Alzheimer's-type dementia and

other patients, and with the use of specialized analysis software, identified movement patterns (variation in two-finger contact time, etc.) unique to sufferers. As a result, it was determined that these movement patterns are highly correlated with indicators evaluated by doctors as revealing impaired cognitive function (Correlation coefficient -0.71).

More data will be accumulated in the future with the aim of developing a more reliable testing method.

18 Industrial Low Voltage Inverter Motor Drive Technologies

In recent years, applications for industrial low voltage inverters have become increasingly diverse, and their role in lifting and lowering devices as well as winding machines has expanded. For these uses, stable high-torque driving in the low-speed range on the order of seconds is required.

In response, Hitachi has developed a new control system that curbs slip variation in motors operating in the low-speed region by calculating the frequency components contributing to increased torque based on motor drive system voltage instructions and using control to feed this back to the command frequency. As a result, at the inverter's minimum output frequency of 0.3 Hz, stable maximum torque driving (200% torque) was achieved with fewer person-hours spent on adjustment compared with previous offerings. When industrial low voltage inverter employing this technology is used in a lifting and lowering device, positioning when the loaded items are lifted or lowered can be performed quickly and accurately.

In the future, Hitachi will fuse this kind of motor

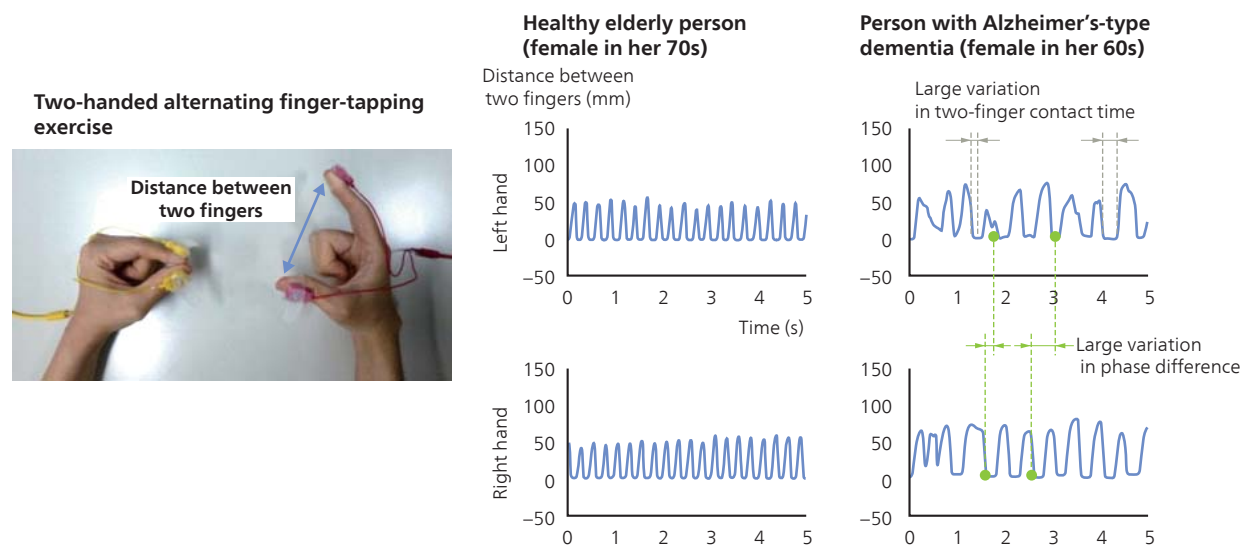

17 Finger-tapping exercises by person with Alzheimer's-type dementia and healthy elderly person



Industrial low voltage inverter

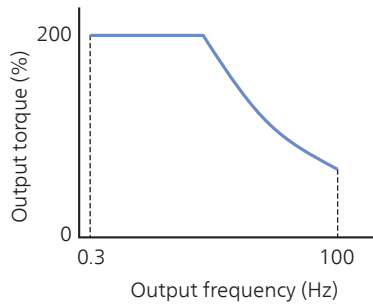

18 Inverter and torque characteristics

drive technology with IoT technologies to create new features for industrial driver systems.

(Hitachi Industrial Equipment Systems Co., Ltd.)

19 High-efficiency Heat Exchanger System for Air Conditioning Equipment

In the field of air conditioning equipment, improving the annual performance factor (APF), an indicator of energy efficiency is most important in competition. Given this, Hitachi developed a high-efficiency heat exchanger system for outdoor units to improve the APF of building air conditioning equipment in variable refrigerant flow (VRF).

Utilizing multi-fidelity total integrated analysis to predict the performance of the overall product system, Hitachi developed a Σ -shaped heat exchanger with higher heat-transfer performance by improving the non-uniformity in velocity distribution from the side of the outdoor unit. In addition, a two-fan structure designed to maximize the effects of the heat exchanger and a high-efficiency long bell mouth with an expanded multistep were developed to reduce fan power by 50%.

These technologies were applied to the building air conditioning equipment commercialized by Hitachi-Johnson Controls Air Conditioning, Inc. in April 2016 and achieved one of the highest APF ratings (6.3 for the flagship 280 model) in the industry.

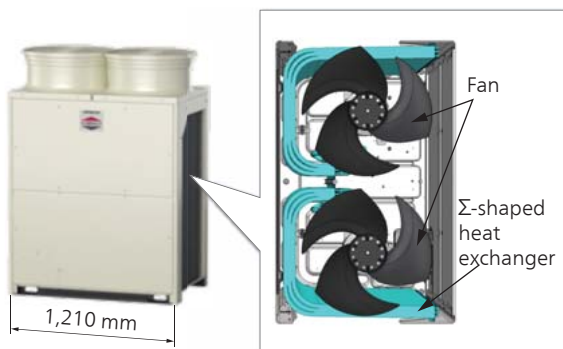

19 Outdoor unit of building air conditioning equipment

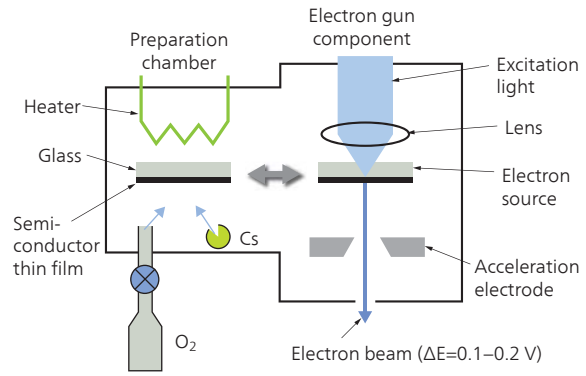

20 Photoexcitation electron gun

20 Technology to Develop High-performance Electron Sources for Electron Microscopes

Scanning electron microscopes (SEMs) are widely used for tasks such as observing the microstructure of new materials and cutting-edge devices, and even higher resolution has been demanded. To achieve this, an electron source that emits electron beams with minimal energy variation (ΔE) with high brightness and stability is essential.

Hitachi has led the world in the development of an electron gun that uses a cold cathode field emission electron source with the small energy variation of 0.3 V, and successfully equipped the electron gun in a high-resolution SEM. In the latest development, gas absorption was reduced and long-term stability with high brightness was achieved by adding a hydrogen exhaust pump to the electron gun. During SEM observation, twice the previous probe current was attained, allowing the acquisition of bright images with an excellent signal-noise ratio (S/N). In addition, as a new technology to reduce ΔE , Hitachi has engaged in research into a photo excitation-type electron source that irradiates a semiconductor thin film with light and emits an electron beam. By incorporating a preparation chamber that controls the surface of the semiconductor thin film and a condensing lens for excitation light into the electron gun, a high luminance and a ΔE of between 0.1 and 0.2 V were achieved.

Hitachi will continue to pursue improved electron source performance.

21 Next-generation Battery for Cars with Auto Start Stop Function

Hitachi has developed a lead storage battery with improved durability for vehicles with auto start stop function. Lead storage batteries equipped in vehicles with auto start stop function, which are expected to

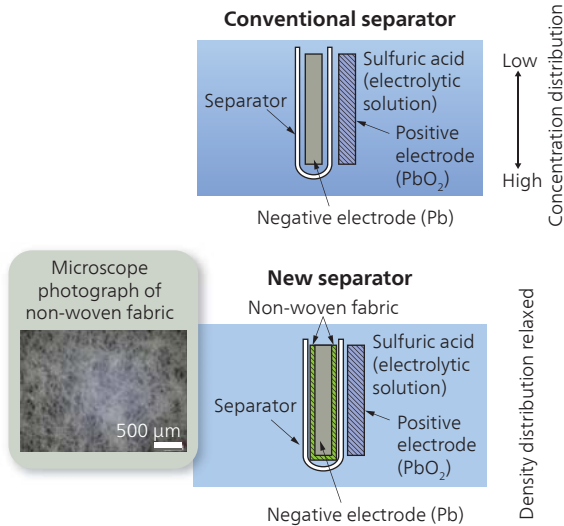

21 Structure of new separator applicable to lead storage batteries for car engaged in auto start stop functions

improve fuel efficiency and reduce CO₂ emissions, have required high charging acceptability in order to accept more regenerated current, as well as improved durability for repeated charge-discharge cycles. By applying a new separator that combines a conventional separator with a hydrophilic-treated non-woven fabric, stratification* has been controlled. As a result, the uneven distribution of cell reaction was alleviated and the durability of the newly-developed lead storage battery was improved by 1.5 times over previous products. What's more, with a non-woven fabric that is a porous membrane, since the

diffusibility of sulfuric acid is maintained, rises in internal resistance in a lead storage battery are controlled while retaining the same charging acceptability as previous products.

The product underwent an advance market launch in June 2016 for light automobiles. Hitachi also plans to release the product for regular passenger vehicles in the future.

* Difference in concentration of electrolyte solution caused by sedimentation of sulfuric acid (electrolytic solution).

22 Cruise Control Technologies Enabling Safe and Comfortable Driving Support and Automated Driving

Hitachi has developed G-Vectoring control and pedestrian behavioral prediction control as cruise control technologies that further enhance the safety and comfort of cars.

G-Vectoring control is an acceleration and deceleration algorithm linked with steering control identified based on the driving behavior of experienced motorists. By enhancing line tracing performance while negotiating curves and smoothly transitioning acceleration profiles, the algorithm offers improved riding comfort. Moreover, with control using mass produced highly responsive engines, in addition to these effects, the effect of reduced driving workload thanks to improved straight travel has been reported.

Pedestrian behavioral prediction control uses the risk potential created based on obstacle information around

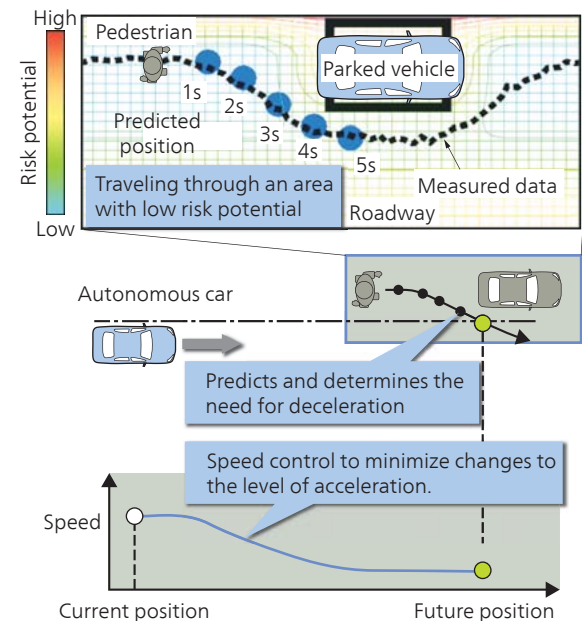
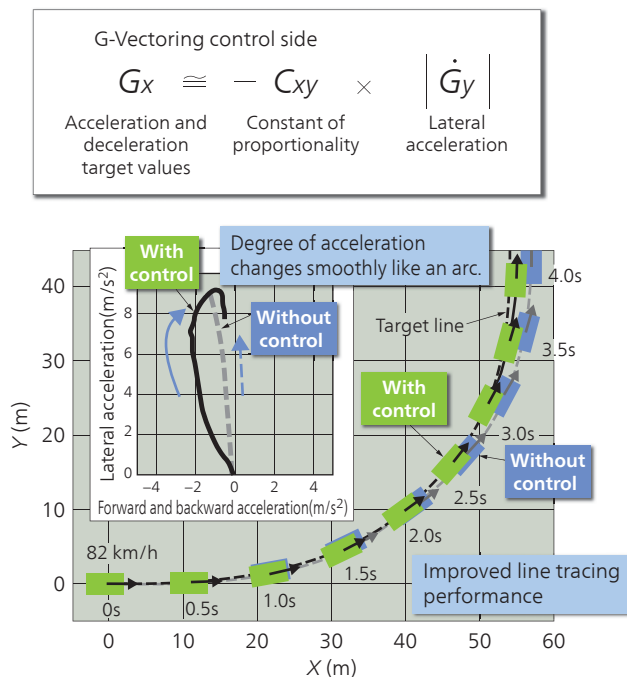

22 Effects of G-Vectoring control when traveling through curves and predicting pedestrian behavior through the potential approach

the route of travel to predict the behavior of pedestrians and control vehicle travel accordingly. This enables speed control appropriate to the situation without initiating excessive deceleration with regard to pedestrians.

These are both important technologies in achieving human-centric car cruise control, and will be widely deployed from driving support to autonomous driving as base technologies of the mobility systems Hitachi provides.

23 Ultra-thin Lens-less Camera Technology for IoT

As they continue to become smaller, thinner and increasingly functional, imaging cameras are key devices in the IoT era. In the latest advancement, Hitachi has developed a lens-less camera in an effort to balance the ultimate in thin design with new functions not found in conventional cameras.

First, a film comprising a grid pattern of round, concentric circles known as a Fresnel zone aperture (FZA) is placed directly in front of the image sensor. Next, FZA shadows illuminated from each point that makes up the subject are detected on the image sensor. When this information is multiplied by a virtual FZA through image processing, a moiré fringe image of straight lines with equal intervals that reflect the direction and pitch of the position where those points lie can be obtained. When the image is subjected to fast Fourier transform (FFT) processing, the subject image can be reproduced as a synthetic point image.

In tests designed to confirm the principle, color slide images displayed on an LCD display were recorded using a 2048 × 2048 pixel image sensor through a film 4 mm away, with the images successfully recorded in real-time at a frame rate of around 30 frames per second.

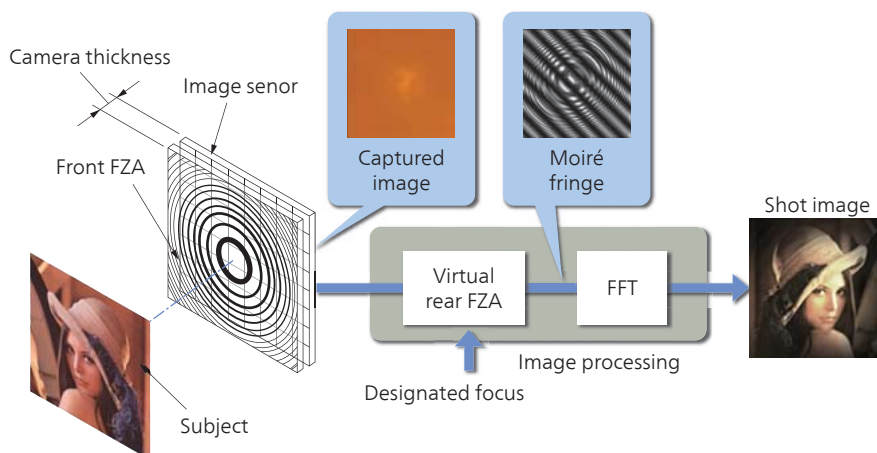

23 Lens-less camera device configuration

By changing variables such as the size and position of the virtual FZA with which the recorded images are multiplied, it is possible to change the focus and perspective for any frame, even after filming, allowing multiple points of focus to be reproduced in real-time.

In the future, Hitachi aims to utilize this type of camera in systems that needed to sense their surroundings such as cars and robots.

24 Development of Rotating Polarization Wave Technology for Reducing Wireless Dead-point.

Social infrastructure systems are required to be operated and maintained both efficiently and securely. Recently, the IoT has emerged to describe a system that monitors and controls equipment belonging to the system using sensors and actuators. Hitachi has developed rotating-polarization-wave (RPW) technology that realizes highly reliable and secure data transmission to reduce the cost of both the construction and maintenance of IoT systems.

RPW is a new transmission mode of electromagnetic waves whose polarizations rotate at different frequencies from that of propagation. The RPW radio provides wireless communication by selecting an optimum polarization of both direct and reflected waves. Hitachi manufactured RPW prototype radios, which are operated at 400 MHz and 900 MHz, and field trials were conducted with the Indian Institute of Technology Madras on its campus via research collaboration with Hitachi Ltd. and Hitachi India Pvt. Ltd. R&D Center. The results show that the RPW radio achieved communication sensitivity that was 10 dB better than conventional machine-to-machine (M2M) radio communication when the bit error rate of the transmission data is less than 10^{-5} .

We will demonstrate RPW communication using the

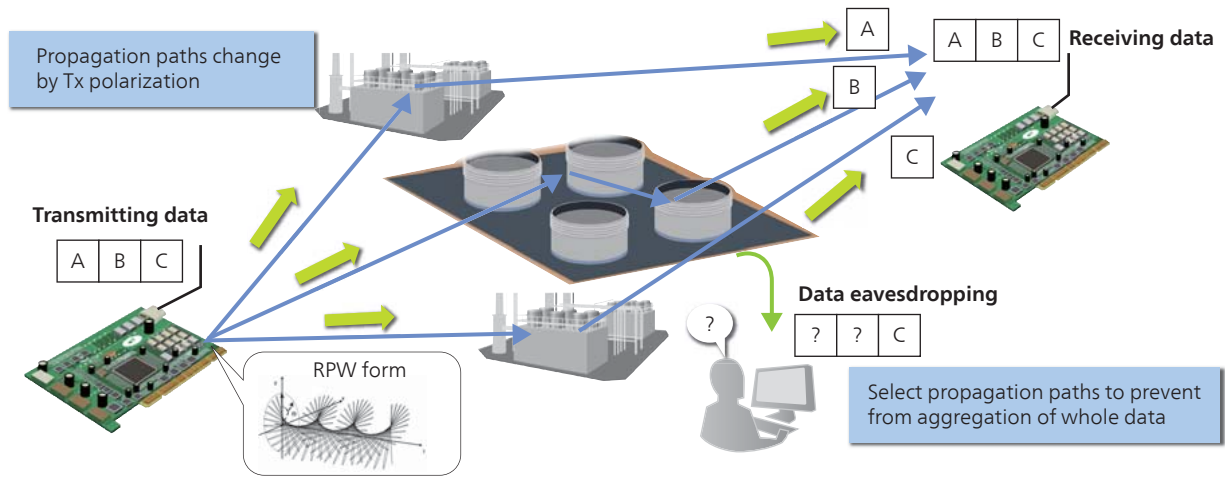

24 Highly-reliable and secure communications through rotating polarization

manufactured prototype to potential customers, and propose solutions for monitoring and controlling social infrastructure equipment.

25 High-temperature Superconducting MgB₂ Wire

As the electrical resistance of superconducting wire is extremely small, it is possible to carry a current at several hundred A/mm², equivalent to around one hundred times the current density of copper wire. By utilizing this characteristic, it is possible for an electromagnet using a superconducting wire to produce a powerful magnetic field, which is used in applications such as

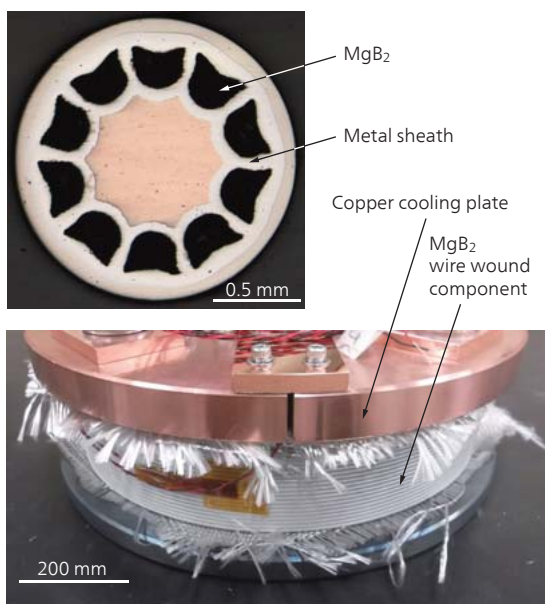

25 Cross-sectional photo of 10-core MgB₂ wire material (top), and an MgB₂ coil made from a 300 m wire of uniform length (bottom)

magnetic resonance imaging (MRI). While a conventional superconducting wire would have to be cooled to around 4 K using liquid helium or similar, the new magnesium diboride (MgB₂) wire is capable of carrying a current of several hundred amperes at between 10 and 20 K.

While these wires are produced by the wire drawing process, the wire length tops out at several meters, and achieving longer, uniform lengths had been an issue. With this new 300 meter-long MgB₂ wire, Hitachi has succeeded in maintaining the complex cross-sectional structure while uniformly drawing wire along its entire length by making improvements to the cross-sectional composition of the wire and wire drawing conditions. In tests to form the wire into a coil and evaluate it while cooled to a temperature of approximately 20 K, the wire managed to carry a 300 A current and produce a magnetic field strength of around 1.5 T, equivalent to that of regular MRI.

Moving forward, Hitachi will continue to pursue development of a wide range of applied equipment.

26 Motion Control Technologies Supporting the High Reliability of Manufacturing Inspection Equipment

Hitachi has developed a distributed real-time network (RTN) controller capable of high-speed computational processing and flexible operation for products such as manufacturing inspection equipment, which require high levels of speed and precision.

Previously, passive damping using rubber or similar materials was the mainstream measure taken to address the issues of vibrations and acoustic noise that can affect product performance, product life and the environment in various ways. On the other hand, although active damping technologies that use sensors and actuators

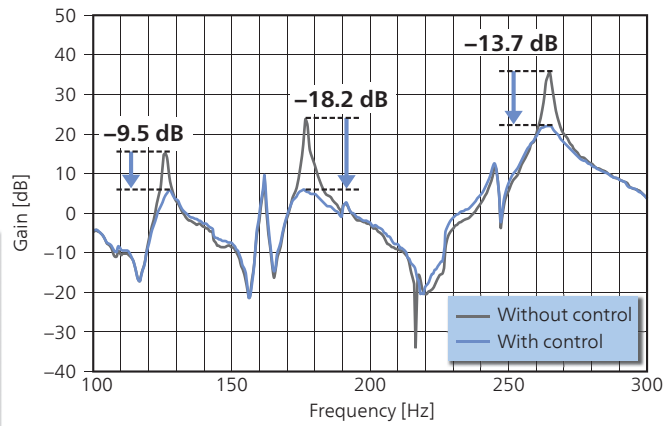
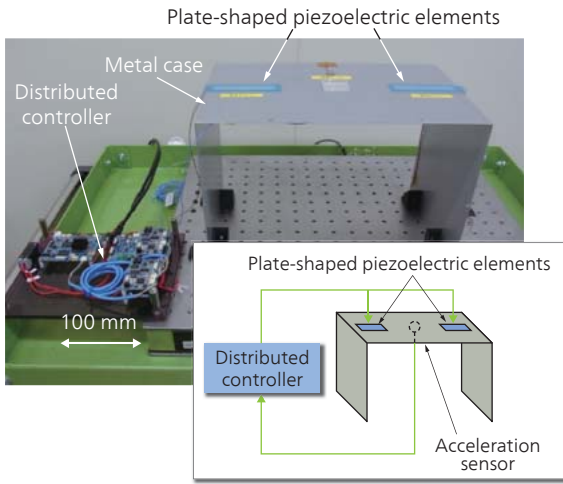

26 Damping effects of distributed general purpose active damper

can be expected to produce high vibration-reducing effects, they came at a high cost and their design required high-level knowledge and experience. Accordingly, active damping systems tended to only be used in large-scale structures and buildings.

Given this situation, Hitachi set about developing distributed general-purpose active damping technologies. This involved the arrangement of multiple sensors and actuators of the right number in the right locations, and carrying out damping through an RTN controller. This allows users to quickly and convincingly reduce vibrations in the target structure, which differ for each usage environment, contributing to higher reliability.

Going forward, Hitachi aims to offer solutions that resolve various issues related to vibration and acoustic noise in social infrastructure and products through motion control technologies.

27 Ceramic Package Substrate that Improves LSI Data Processing Capacity

The processors used for applications such as deep learning and autonomous driving, which need to process large volumes of data at high-speed, require memory-to-memory data transmission capacities of as much as one terabyte per second, more than ten times greater than a personal computer (PC). To meet this requirement, silicon interposer (SiIP) technologies have been proposed. A SiIP connects the memory to the processor with thousands of wires to boost the parallelism of data transmissions. However, forming pass-through electrodes that allow signals to pass between the front and back of a silicon substrate require specialized processes, and costs due to the higher mounting frequency had been an issue. To address this, the Hitachi, Ltd.'s Research and Development Group and Hitachi Metals, Ltd. worked on a joint basis to

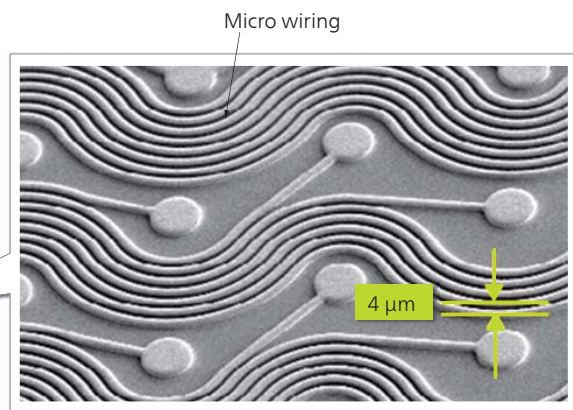
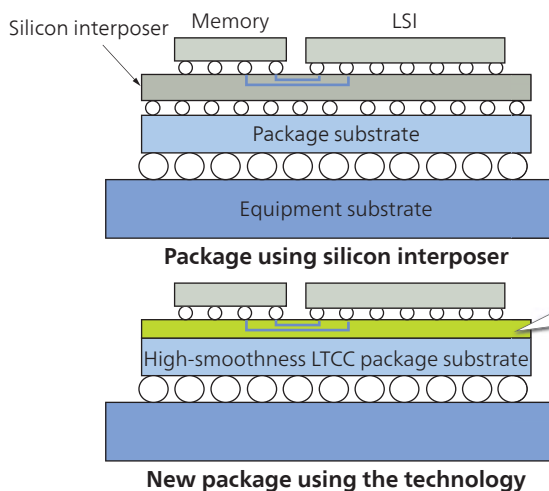

Wiring pattern for data transmission between memory modules

LSI: large-scale integration

27 Development package structure and micro wiring on LTCC substrate

develop a package substrate that omits SiIP by forming micro wiring directly onto the substrate.

A flat surface is needed to form micro wiring on a substrate. However, due to the nature of ceramics, which is formed by sintering the raw material particles to form substrate crystals, problematic holes and warpage would occur. To deal with this, low-temperature co-fired ceramics (LTCC) that exhibit a lower hole rate by reducing density loss during crystallization as well as a high-precision polishing technology were developed. This allows the wiring pitch to be reduced to 4 μm and as a result, terabyte-per-second memory-to-memory data transmission is likely to be achieved at a lower cost than with SiIP technologies.

In the future, Hitachi will seek to deploy the technology in high-performance computing (HPC) for data centers, and in automotive components.

28 Material Analysis Technologies Facilitating Improved Functionality in High-voltage Insulating Resins

Improved resin functionality through the addition of nano-particles has attracted attention as a way to make high-voltage equipment smaller and more reliable. Hitachi is currently working to improve the functionality of resins and is pursuing the development of kinetic analysis technologies that treat molecular assemblies as a single particle in order to predict nano-particle distribution and insulation breakdown speed.

In kinetic analysis, interparticle force inside the resin needs to be determined, and speeding up this process has been an issue. While at least an analysis area on the order of several millimeters representing the range of the interparticle force is required to predict nano-particle distribution, considering realistic computational times, in conventional interparticle force analysis the limit was analyzing an area on the order of several dozen nanometers.

Given this, Hitachi applied the fast multipole method*, which is utilized in fields such as astronomy, in an effort to boost speed by 10⁵ times that of previous offerings. In calculations using the interparticle force derived using the conventional analysis area, it was difficult to predict the nano-particle distribution within the resin, but the application of this technology has made it possible to predict nano-particle distribution by enlarging the analysis area to perform calculations. While nano-silica with a hydrophilic modified base has uniform structure in resin, nano-silica with a hydrophobic modified base assumes the unique distribution of a network structure to curb the advancement of insulation breakdown. As the developed technology is able to predict the differences in nano-particle distribution and insulation breakdown that occurs due to minute changes (modified base, etc.) in the nano-particles, there are expectations that it will be utilized in the future as an analysis technology that supports the improved functionality of insulating resins for a wide variety of smaller and more reliable high-voltage equipment.

* A method that performs a Taylor expansion on interparticle forces centered around each cube with the space treated as an aggregate of small cubes.

29 Technology to Design Highly-adhesive Materials through Materials Informatics

As resin materials are well suited to reducing weight, they are used in a wide variety of products from electronic components to power equipment. However, resin materials have weaker adhesion to inorganic materials such as metals, and peeling is often an issue. Given this, using a technology to identify the important factors in material design by analyzing data through informatics (multivariate analysis), which is known as materials informatics, Hitachi analyzed the data from molecular dynamics calculations and developed a

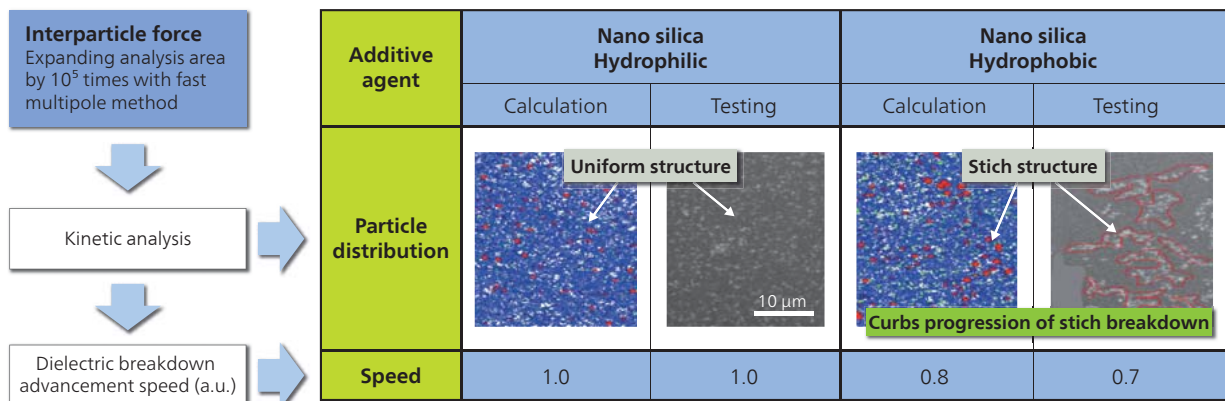

28 Nanoparticle distribution in resin and results of predictive analysis of dielectric breakdown speed

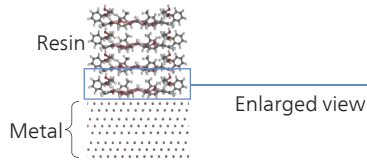
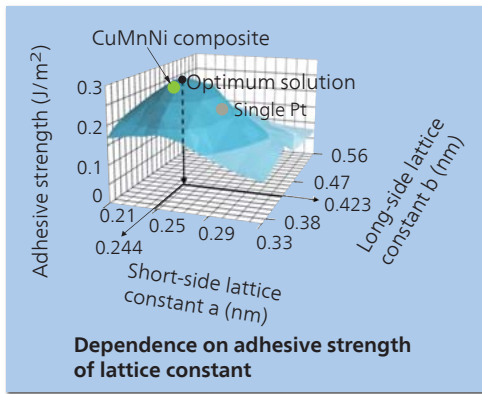

Interface seen from the side

For Cu, Mn and Ni composite materials

Lattice matching structure with metal atoms peeking through the center of naphthalene rings

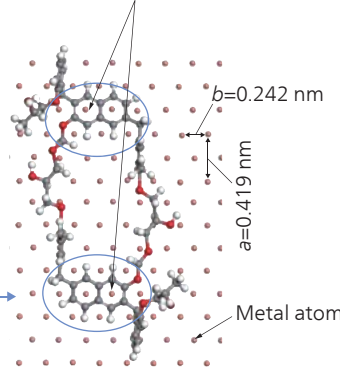

Interface seen from above

When a simple Pt substance is used

Non-matching structure without metal atoms peeking through the center of naphthalene rings

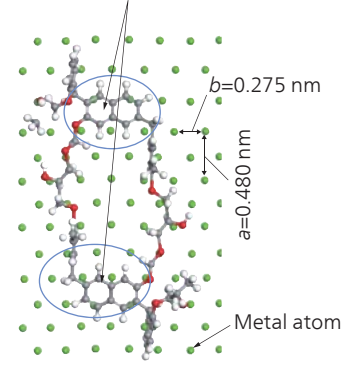

Interface seen from above

29 Sample design of a metal laminated film exhibiting high adhesive strength with resin

technology that efficiently designs metal materials that bond well with resins.

As a result of using this technology to analyze the most important factors in increasing adhesive strength, Hitachi found that the lattice constant of metal is a controlling factor, and that adhesive strength is the greatest when the short-side lattice constant $a = 0.244$ nm and long-side lattice constant $b = 0.423$ nm. Based on this knowledge, Hitachi selected multiple metallic elements that are close to the aforementioned optimum values for a and b , and adjusted the lattice constant by combining them. As a result, it was learned that through a composite material made from copper (Cu), manganese (Mn) and nickel (Ni), a lattice constant closest to the aforementioned optimum values ($a = 0.242$ nm, $b = 0.419$ nm) can be obtained, and that the

composite material represents a gain in adhesive strength of approximately 40% compared with a thin film made from platinum (Pt) alone. As for the mechanism behind this high adhesion, in the case of this composite material, a lattice matching structure with metal atoms peeking through the center of naphthalene rings was determined to have the effect of strengthening interparticle bonds.

Moving forward, Hitachi plans to apply the technology to the design of items such as lithium-ion battery electrodes and high-strength alloys.

30 Multi-fidelity Total Integrated Analysis Technologies to Predict Total Product System Performance

With the development of industries and cities in recent

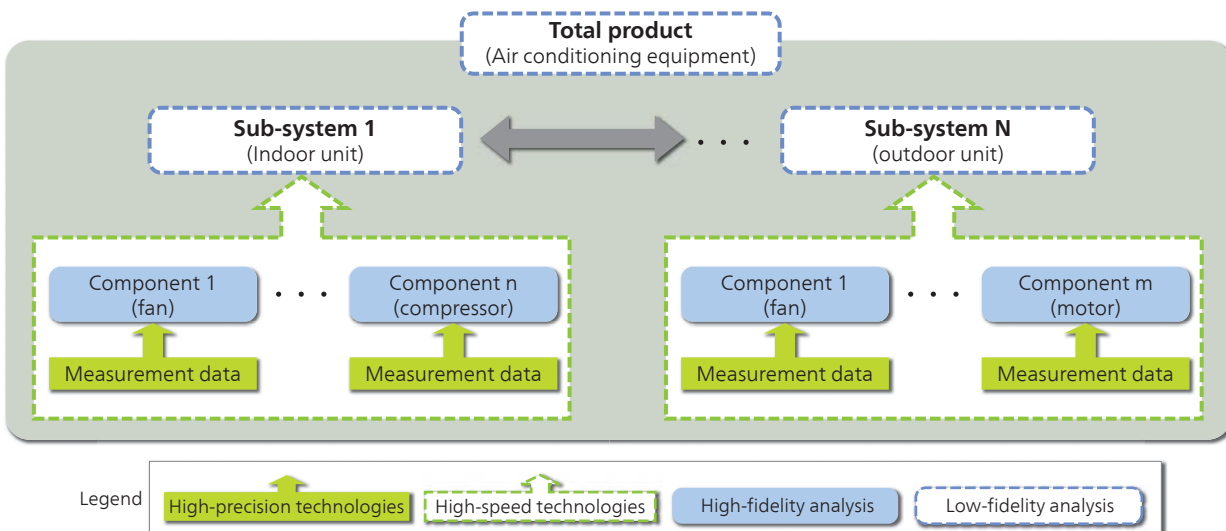

30 Overview of multi-fidelity total integrated analysis technologies

years, the social infrastructure products to support them, such as building air conditioning equipment, have also grown in size and complexity. This has in turn fueled the need for analysis technologies capable of predicting total product performance with high precision and in a short time so that highly-reliable products can be developed. To address this, Hitachi has developed multi-fidelity total integrated analysis technologies as a means of predicting the total system performance of social infrastructure products comprising multiple components.

Traditionally, to analyze the total system, analyses have been carried out individually for each layer—components, sub-systems and total system, using one-dimensional analysis and three-dimensional analysis. However, these technologies enable batch analysis by selecting, adjusting and combining analysis models according to the required level of precision in predicted performance.

Hitachi applied the newly-developed analysis technologies to predict the coefficient of performance (COP) in air conditioning equipment and as a result, the analysis time was shortened from the usual 2.5 days to around ten minutes, while the prediction error of COP change was improved from a previous figure of about 3% to less than 1%.

Looking ahead, Hitachi will also utilize this advancement in product development for automotive equipment and construction machinery as it looks to contribute to the creation of highly-reliable social infrastructure products that swiftly cater to customer needs.

31 Technologies to Sharpen Ultrasonic Wave-based Electronic Component Inspection Images and Detect Microdefects

As society becomes increasingly information-driven and the adoption of electronics continues, the electronic components as key devices in mobile equipment and cars have become highly integrated. To ensure the reliability of these electronic components, there is a growing need to conduct high-precision ultrasonic tests of component internals at development and manufacturing sites. With this in mind, Hitachi has developed the following technologies related to ultrasound images of increasingly smaller and complex circuit patterns.

(1) Image sharpening technology based on probe specifications that predicts image blurring due to the ultrasonic intensity distribution during imaging and removes the blurring through the deconvolution process.

(2) Technology that detects defects of the same size as manufacturing tolerances through statistical processes using the regularity of the circuit pattern.

These technologies were equipped in a scanning acoustic tomograph (SAT) from Hitachi Power Solutions Co., Ltd. As a result, visibility in images of electronic components requiring high levels of reliability was improved by 1.6 times, while the automatic detection of defects with a diameter of 10 μm in stacked wafer was also achieved.

In the future, Hitachi will strive to further enhance inspection performance and expand analysis features in an effort to incorporate reliability into the production of a wide range of industrial products equipped with electrical components, and to help stabilize quality.

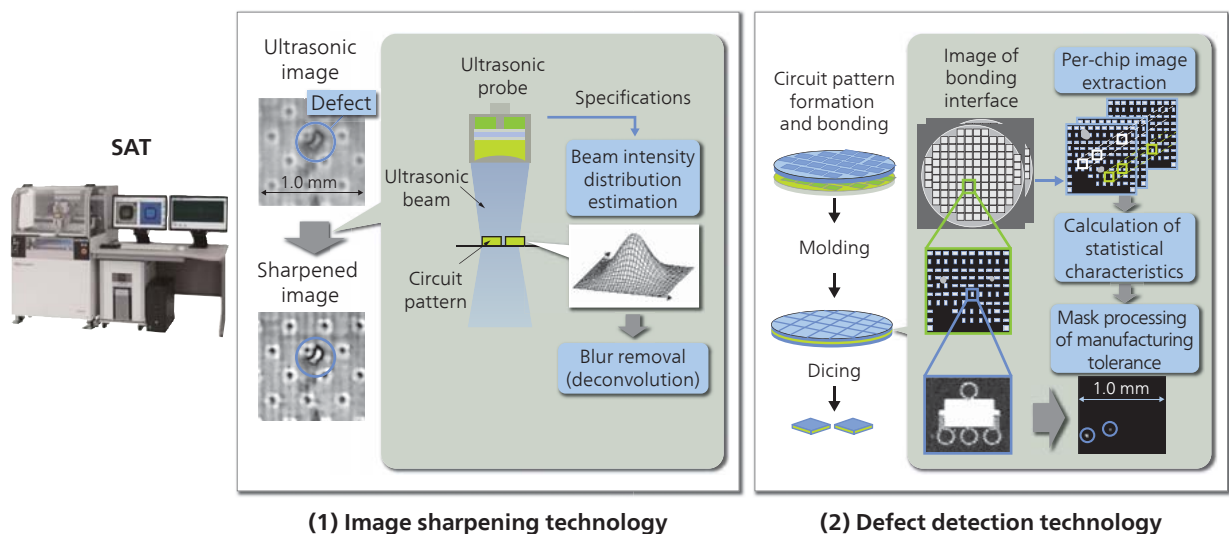

31 Ultrasonic image processing technologies

32 Soft Error Assessment Technologies Using Low-energy Neutron Beams

With the increasingly miniaturized semiconductor fabrication process, semiconductor circuits have become more susceptible to bit inversions (soft errors) caused by neutrons flying from space, and there are growing concerns about malfunctions in electronic devices as a result. As conventional neutron tolerance assessments of electronic devices have involved simulating the energy distribution of neutrons that come flying to earth, the devices being tested would be irradiated with high-energy neutron beams with up to 200 MeV of energy that were generated using particle accelerators. However, these tests involved high costs and the limited evaluation facilities were an issue.

Given this, Hitachi has developed a technology to estimate the soft error rate using low-energy neutron beams on the order of 40 MeV using a compact particle accelerator that features low-cost operation and a large number of installed units. Consequently, evaluation

costs were reduced to one-tenth the previous level. The newly-developed technology utilizes information on neutron beam energy distribution and the neutron energy dependency on soft error rates (soft error cross section function) that has already been compiled into a database. Using the results of low-energy neutron beam irradiation tests, the high-energy area where the soft error cross section function unique to electronic devices becomes 40 MeV and higher is estimated.

In addition, the soft error rate for electronic devices was also derived by multiplying the calculated soft error cross section area function with the distribution of neutron energy occurring in nature. The soft error rate when this technology is applied fell within 20% of the measurement error produced when conventional technologies are applied.

In the future, Hitachi hopes make contributions to each business field by improving the neutron tolerance of the electronic devices used in cars, rail, nuclear power and so on.

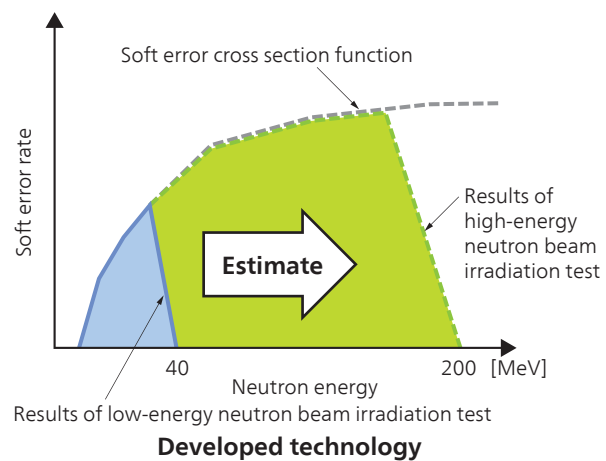
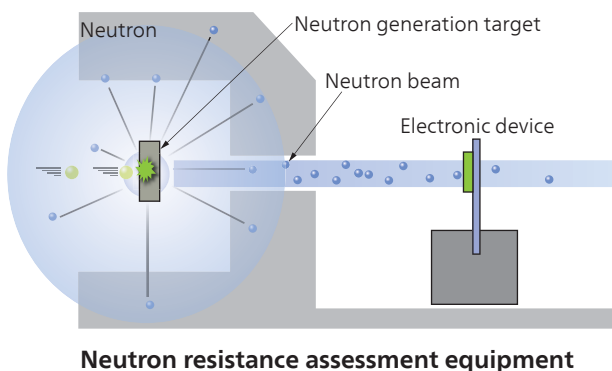

32 Overview of soft error rate assessment through low-energy neutron beam irradiation